



# eqss™ Gen-3 LMS Telehandler Load Management System

## Installation Manual for TL38.70 with Boom Suspension



### **PLEASE NOTE:**

**\*\*\*Do Not Swap Components between Gen3-LMS kits\*\*\***

**When installing multiple Gen3-LMS kits, make sure the serial number on the sticker matches the serial number on the machine.**

**\*\*\*Failure To Follow Installation Manual Will Void Warranty\*\*\***

## Documentation Conventions

The list below highlights important documentation conventions.



Text presented in this manner is intended to provide the user with some general information. The user should ensure information presented in this manner is clearly understood.



Text presented in this manner provides the user with information to assist in completion of the current procedure being explained.



Text presented in this manner indicates that a failure to follow directions could result in damage to equipment, loss of information, bodily harm, or loss of life.

## **Important Information**

Information contained in this publication regarding this device's applications and the like is provided only for your convenience and may be superseded by updates. It is your responsibility to ensure that the application or our equipment meets with your specifications.

EQUIPMENT SAFETY SYSTEMS MAKE NO REPRESENTATIONS OR WARRANTIES OF ANY KIND WHETHER EXPRESS OR IMPLIED, WRITTEN OR ORAL, STATUTORY OR OTHERWISE, RELATED TO THE INFORMATION, INCLUDING BUT NOT LIMITED TO, IT'S CONDITION, QUALITY, PERFORMANCE, MERCHANTABILITY OR FITNESS FOR PURPOSE.

Equipment Safety Systems disclaims all liability arising from this information and its use. Use of Equipment Safety Systems' products as critical components in life support systems is not authorised except with express written approval by Equipment Safety Systems. No licenses are conveyed, implicitly or otherwise, under any Equipment Safety Systems intellectual property rights.

# Table of Contents

Tools Required for Installation.....	5
Installation Index.....	6
Covers.....	9
Cable Reeler Installation.....	11
Cable Reeler Mounting Position.....	13
Pressure Sensor Installation.....	14
Main Cylinder Pressure Sensors.....	14
Compensation Pressure Sensors.....	16
Reverse Camera.....	18
Can Pressure Input Module (CPIM).....	20
Signal Light Installation.....	21
Forward Camera.....	23
External Cable Completion.....	25
Display Installation.....	29
User Input Control.....	31
Can Cabin Interface Module (CCIM).....	32
Machine Connections.....	33
Cabin Loom.....	36
Finalisation.....	39
Set Time & Sensor Calibration.....	42
Schematics.....	45
Appendix A: Attaching Display Connectors.....	48
Appendix B: Reattach Ferrites.....	52
Indexes and Tables.....	53

# Tools Required for Installation

The tools required to perform the installation of the TSS are listed below

- Pencil or Texta
- Drill
- Drill bits
  - 3.3 mm
  - 4.5 mm
  - 5 mm
  - 6.8 mm
  - 8.5 mm
- Centre punch
- Tap T-Handle
- Taps
  - M6
  - M8
- Drill and tap oil
- Metric Allen keys
- Phillips Head screw driver
- Spanners and sockets
  - 7 mm
  - 10 mm
  - 13 mm
- Loctite thread locker
- Side cutters
- Stanley knife
- Crimpers
- Wire strippers
- Torque Wrench

# Installation Index

The components and cables of the Gen-3 Telehandler Load Management System are outline in the tables below. The following pages show where the components are installed and the cable routing.

See the appropriate manual section for a detailed installation description for each component.



Refer to this section for any component placement or cable routing issues

<i>Item</i>	<i>Component Description</i>
1	Cable Reeler
2	Main Lift Cylinder Pressure Sensors
3	Compensation Cylinder Pressure Sensors
4	Can Pressure Input Module (CPIM)
5	Cutout Connections
6	Lock Pin Release Connection
7	Forward Camera
8	Signal Light
9	Rear Camera

Table 1: Component Installation Index

<i>Colour</i>	<i>Cable Description</i>
Light Purple	Boom Cable
Dark Green	Main Cylinder Pressure Sensor Cables
Dark Blue	Compensation Cylinder Pressure Sensors Cables
Red	Cutout Harness
Orange	Lock Pin Release Harness
Light Green	Forward Camera Cable
Brown	Signal Light Cable
Light Blue	Rear Camera Cable
Dark Purple	CCIM Cable

Table 2: Cable Installation Index



*Illustration 1: Machine Boom*









Illustration 2: Machine Chassis



# Covers

Remove the following covers before starting the installation

<i>Step</i>	<i>Description</i>	<i>Diagram</i>
1.	Remove the rear covers and disconnect the license plate light.	
2.	Remove the side panel next to the cabin under the boom.	
3.	Remove the cover under the steering wheel.	

<i>Step</i>	<i>Description</i>	<i>Diagram</i>
4.	Undo the bolts attaching the dashboard.	

*Table 3: Cover removal*

# Cable Reeler Installation

The cable reeler is used to measure the boom extension to determine the maximum lifting capacity.



A false N07 fault can occur if the boom jumps off the stow switch due to pressurising the hydraulic system and without operating the boom extension control. Ensure the stow switch arm is correctly adjusted to prevent this error.

<i>Step</i>	<i>Description</i>	<i>Diagram</i>
1.	<p>Drill the holes for the cable reeler mounting plate according to the mounting diagram on page 13.</p> <p>Mount using the supplied M8 x 30 mm bolts, nuts and washers.</p>	
2.	<p>Drill and tap an M8 hole for the cable anchor. Ensure the cable anchor is positioned so the cable runs in line with the boom.</p> <p>Mount the cable anchor and attach the cable.</p>	
3.	<p>Drill and tap the M6 holes for the stow switch trigger bracket.</p> <p>Mount the stow switch trigger bracket using the supplied M6 x 12 mm bolts and washers.</p> <p>Adjust the length of the trigger plate to ensure the stow switch is pressed when the boom is retracted.</p>	



<i>Step</i>	<i>Description</i>	<i>Diagram</i>
4.	Connect the supplied M12 10 metre cable (CB001027) into the cable reeler connection.	
5.	<p>Run the cable down the top of the boom, place cable tie points every 500 mm down the boom and secure the cable to the cable tie points.</p> <p>Cable tie to the flexible hydraulic hoses down to the chassis. Make sure the cable isn't pinched or stretched when the boom is raised or lowered.</p> <p>Cable tie with the other cables during External Cable Completion on page 25.</p>	

Table 4: Cable Reeler Installation

 For further details on running the boom cable refer to the Installation Index on page 6



# Cable Reeler Mounting Position

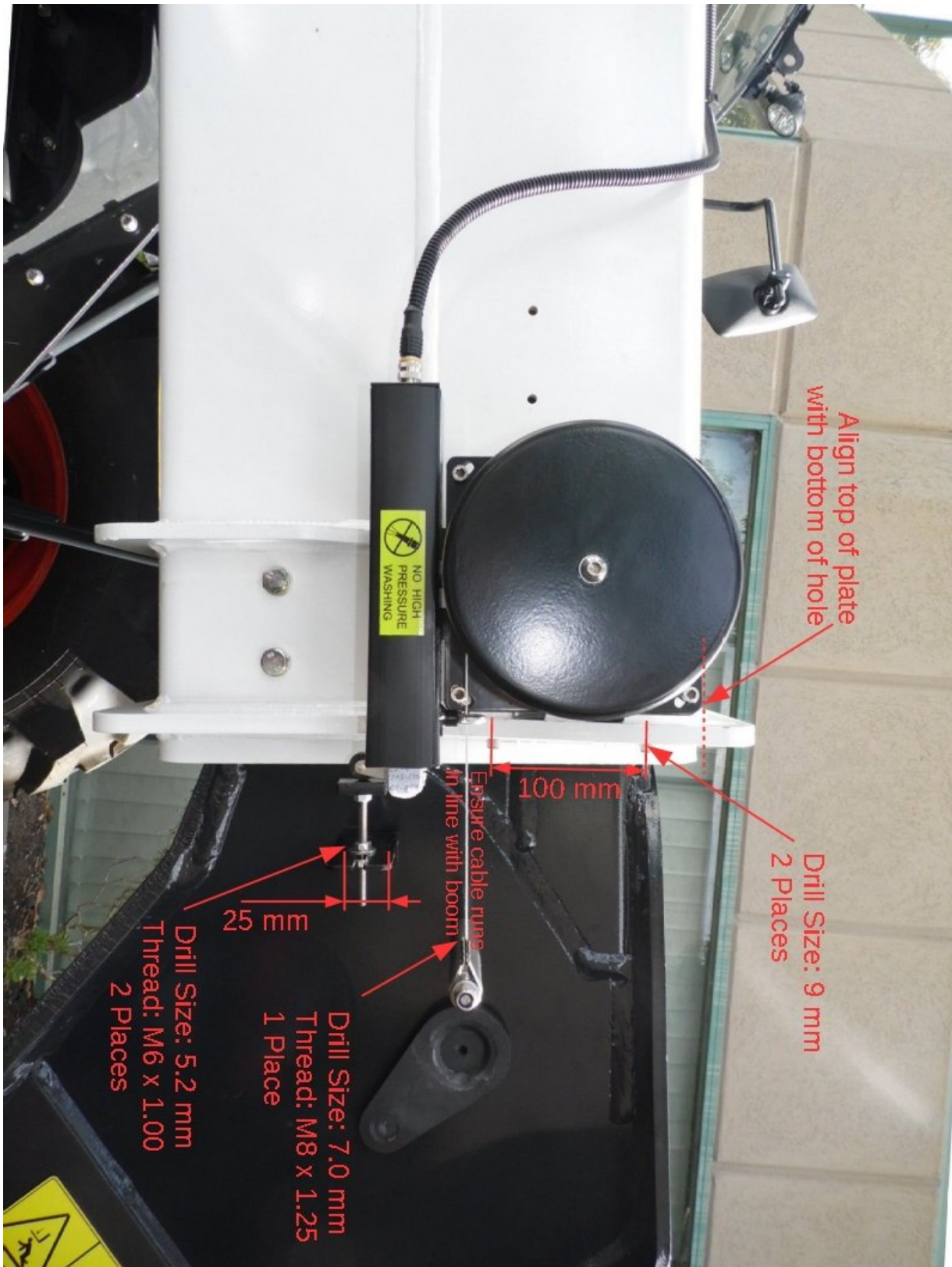
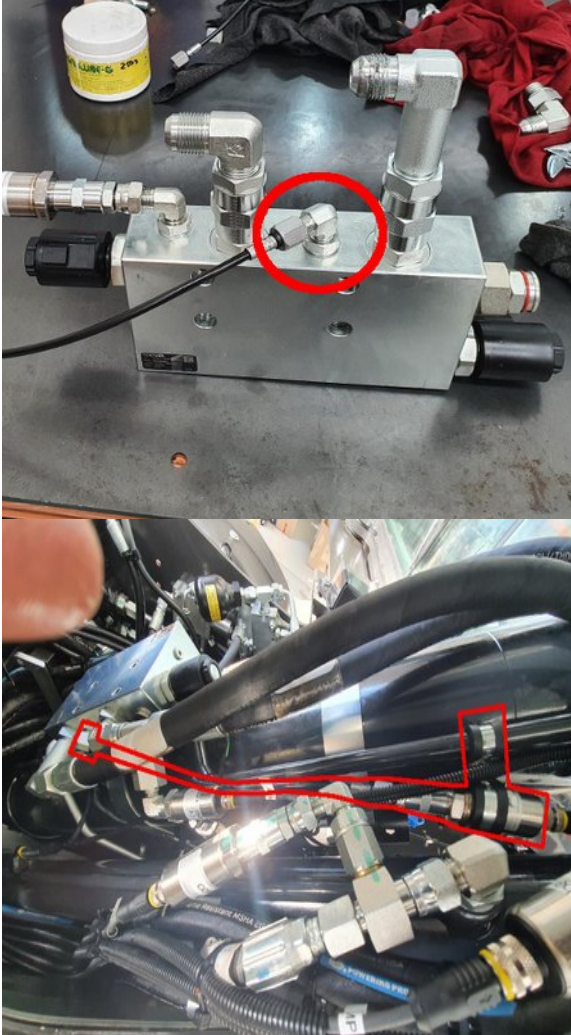

Illustration 3: Cable Reeler Mounting Position

# Pressure Sensor Installation

The hydraulic pressure sensors are used to measure the lifting load of the telehandler.

## Main Cylinder Pressure Sensors

<i>Step</i>	<i>Description</i>	<i>Diagram</i>
1.	<p>Raise the boom to approximately 40 degrees.</p> <p>Support and secure the boom using an A Frame or similar apparatus. <b>It must support at least 2 tons.</b></p> <p>Apply the handbrake and insert chock under wheels.</p> <p>Release the blanking cap on the side of the manifold highlighted in the image.</p> <p><b>Removing the blanking cap will release the hydraulic pressure which may result in a spray of oil.</b></p> <p>Install the supplied head pressure sensor and hydraulic fittings and ensure it is tightly sealed.</p> <p>Clamp the pressure sensor to the fixed hydraulic line using the supplied p-clips, nut, washer and bolt.</p>	







<i>Step</i>	<i>Description</i>	<i>Diagram</i>
2.	<p>Install the supplied rod pressure sensor and hydraulic fittings and ensure it is tightly sealed.</p> <p>Ensure the hydraulic fittings are angled as shown to ensure they don't hit the bottom of the boom at minimum boom angle.</p> <p><b>Start the machine, pressurise the boom and check for leaks and check for clearance between the.</b></p>	
3.	<p>Connect the supplied M12 4 metre cables (CB001026) into each of the pressure sensors.</p> <p>Cable tie the pressure sensor cable to the flexible hydraulic hoses connected to the main lift cylinder. Make sure the cable isn't pinched or stretched when the boom is raised or lowered.</p> <p>Run the cables towards the rear of the machine and cable tie with the other cables during External Cable Completion on page 25.</p> <p><b>Ensure the pressure sensors and cables do not collide with the boom and chassis structures and the cables do not stretch or pinch when the boom is raised and lowered.</b></p>	

Table 5: Pressure Sensor Installation

# Compensation Pressure Sensors

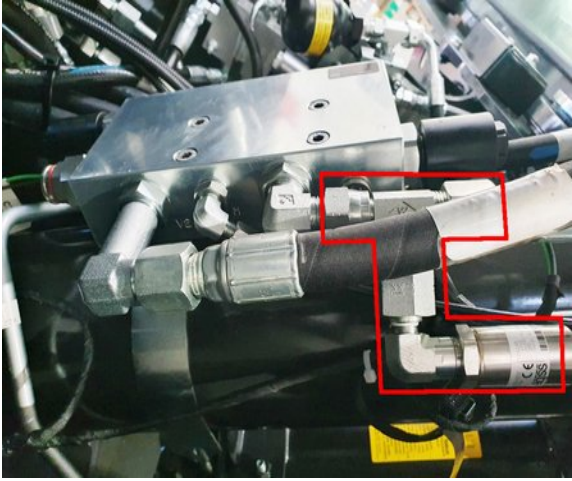
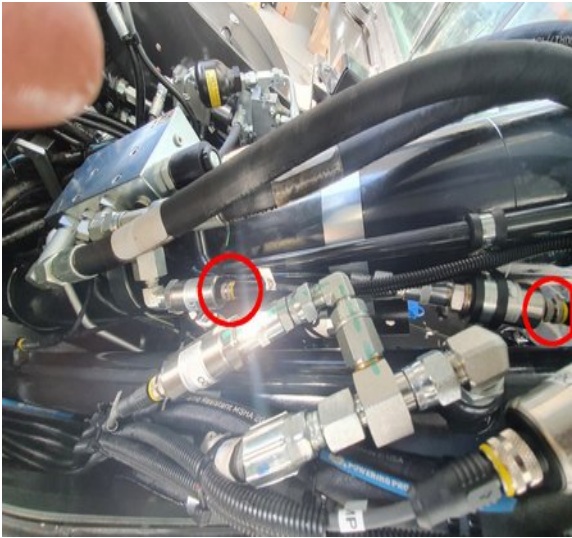
<i>Step</i>	<i>Description</i>	<i>Diagram</i>
1.	<p>Undo the flexible hydraulic hose connection into the top port on the compensation cylinder.</p> <p>Install the supplied Rod pressure sensor and tee connections and reconnect the flexible hydraulic hose.</p> <p>Ensure the pressure sensor and the hydraulic hose connections are against the side of the chassis, to ensure they don't hit the boom when at lower boom angles.</p>	
2.	<p>Undo the flexible hydraulic hose connection into the bottom port on the compensation cylinder.</p> <p>Install the supplied Head pressure sensor and tee connections and reconnect the flexible hydraulic hose.</p> <p>Ensure the pressure sensor and the hydraulic hose connections are against the side of the chassis, to ensure they don't hit the boom when at lower boom angles.</p> <p><b>Start the machine, pressurise the boom and check for leaks and check for clearance.</b></p>	

<i>Step</i>	<i>Description</i>	<i>Diagram</i>
3.	<p>Connect the supplied M12 4 metre cables (CB001026) into each of the pressure sensors.</p> <p>Cable tie the rod pressure sensor cable to the flexible hydraulic hoses connected to the main lift cylinder along with the main pressure sensor cables. Make sure the cable isn't pinched or stretched when the boom is raised or lowered.</p> <p>Run the cables towards the rear of the machine and cable tie with the other cables during External Cable Completion on page 25.</p>	

*Table 6: Compensation Pressure Sensor Installation*

# Reverse Camera

The rear camera video is displayed on the screen when the machine is in reverse gear to allow the operator to see behind the telehandler while reversing.

 Do not disconnect the camera power connection while the system is operating as this can damage the fuse.



<i>Step</i>	<i>Description</i>	<i>Diagram</i>
1.	<p>Drill a 31mm hole in the location shown in the rear cover. Making sure to leave enough room for a license plate</p> <p>Insert the camera through the hole and adjust the angle using the alignment washers.</p>	
2.	<p>Connect the camera power and signal connectors to the supplied 5m camera cable (CB001032).</p> <p>Note; The white connector is not used.</p> <p>Run the remainder of the cable towards the cabin and insert into cabin during External Cable Completion on page 25.</p>	

Table 7: Reverse Camera Installation

 The camera's viewing angle may need to be adjusted once the system is installed and the display is operational.



For further details on running the camera cable refer to the Installation Index on page 6



# Can Pressure Input Module (CPIM)

The CPIM is responsible for processing the information send from the pressure sensors.



Accidentally swapping the pressure sensor connections will not damage the system.



Do not plug the pressure sensor cable into the far right side boom cable. This will damage the system.



<i>Step</i>	<i>Description</i>	<i>Diagram</i>
1.	<p>Drill two M8 holes for the CPIM bracket in the side of the chassis.</p> <p>Mount using the supplied M8 x 30mm bolts, nuts and washers.</p>	
2.	<p>Connect the cables for the pressure sensors and boom cable to the CPIM according to the picture shown.</p> <p>Note: The CCIM cable will be installed during External Cable Completion on page 25.</p>	

Table 8: Can Pressure Input Module (CPIM) Installation





# Signal Light Installation

The signal light warns other workers when the telehandler is lifting loads close to its maximum capacity.

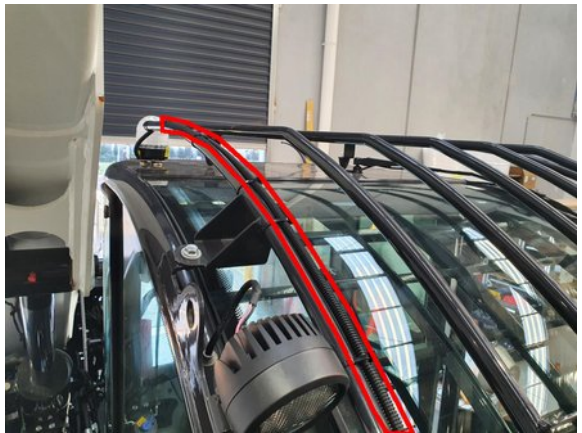

Ensure the power supply voltage is greater than 13.5V otherwise the signal light may not illuminate correctly.

<i>Step</i>	<i>Description</i>	<i>Diagram</i>
1.	Mount the signal light to the top of the cabin using the magnetic anchor.	
2.	Secure the cable with cable ties along the front window guard.	

<i>Step</i>	<i>Description</i>	<i>Diagram</i>
3.	Run the cable down to the grommet at the side of the cabin.	

*Table 9: Signal Light Installation*

# Forward Camera

The forward camera video is displayed on the screen when the machine is in forward gear to allow the operator to see past the boom to obstructions that would damage the right front tyre.



Do not disconnect the camera power connection while the system is operating as this can damage the fuse.



<i>Step</i>	<i>Description</i>	<i>Diagram</i>
1.	<p>Mount the camera to the side mirror post using the p-clips as shown.</p> <p>Secure using two M6 nuts.</p>	
2.	<p>Connect the camera power and signal connectors to the supplied 5m camera cable (CB001032).</p> <p>Note; The white connector is not used.</p> <p>Run the cable along the same path as the headlight cable through the headlight post.</p> <p>Run the remainder of the cable towards the cabin following the headlight cable and insert into cabin during External Cable Completion on page 25.</p>	

Table 10: Forward Camera Installation





The camera's viewing angle may need to be adjusted once the system is installed and the display is operational.





For further details on running the camera cable refer to the Installation Index on page 6

# External Cable Completion



All external cabling is completed in this step.

<i>Step</i>	<i>Description</i>	<i>Diagram</i>
1.	Install the supplied grommet in the location shown in the image.	
2.	Run the two pin connector pairs from the cutout and lock pin release harnesses through the connector hole from inside the cabin to the outside of the chassis.	

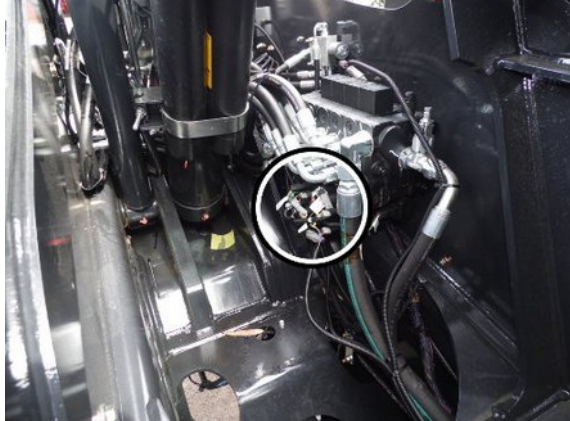

<i>Step</i>	<i>Description</i>	<i>Diagram</i>
3.	Connect the supplied M12 4 metre cable (CB001026) into the right side of the CPIM for the CCIM cable.	
4.	<p>Run the cutout and lock pin release harnesses along the same path under the chassis covers as the existing electrical harnesses towards the spool assembly at the rear of the machine.</p> <p>Run the CCIM and rear camera cables along the same path as the existing electrical harnesses towards and through the hole into the cabin.</p>	
5.	<p>Run the two pin connectors on the lock pin release harness up to the lock pin release solenoid valve and secure in place using cable ties.</p> <p>This will be connected into the solenoid valve during Finalisation on page 39.</p>	
6.	Run the pair of two pin connectors on the height limit cable from out the side of the CPIM module and the two pin connectors from the cutout harness to the spool assembly.	

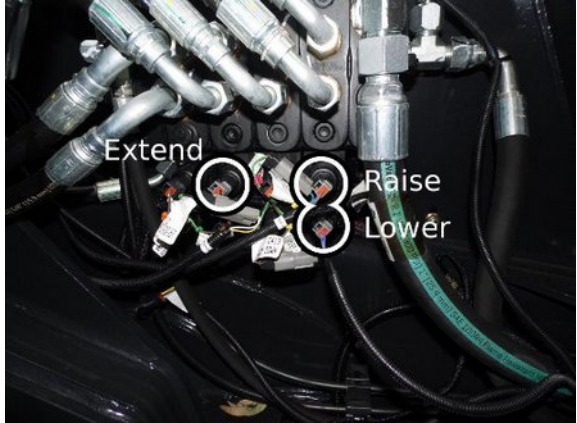

<i>Step</i>	<i>Description</i>	<i>Diagram</i>
7.	<p>Connect into the spool assembly as shown and secure in place using cable ties.</p> <p>Once secure remove the connections so that the boom will function.</p> <p>These will be reconnected into the solenoid valves during Finalisation on page 39.</p>	
8.	<p>Coil up the additional cabling for the pressure sensor, CCIM and boom cables and store underneath the CPIM.</p>	 <p>View from behind the cabin</p>
9.	<p>At the front of the machine cable tie the signal light and forward camera together and run towards the cabin.</p>	

<i>Step</i>	<i>Description</i>	<i>Diagram</i>
10.	<p>Run the CCIM, signal light and camera cables up through the hole into the cabin.</p> <p>Note: Pull a short length of cable through into the cabin. Store excess cable under the cover on the side of the chassis.</p>	

*Table 11: External Cable Completion*

# Display Installation

The display shows the current safety status of the telehandler.



<i>Step</i>	<i>Description</i>	<i>Diagram</i>
1.	Remove the rear mirror from the right column.	
2.	Using the supplied M3 screws and bolts, mount the Display Bracket to the same mounting location of the removed rear-view mirror.	
3.	Mount the display to the installed display-bracket and connect the 2 X M12 screw-lock connectors to the back of the display.	

Table 12: Display Installation



Adjust the display bracket for optimal viewing angle once the display is powered



If the M12 screw lock connectors on the display are over tightened it will twist the connector pins attaching the connector to the PCB. See Appendix A: Attaching Display Connectors on page 48 for the correct method of attaching to the display connectors.

# User Input Control

The user input control consists of a single dial switch mounted in the dashboard.



<i>Step</i>	<i>Description</i>	<i>Diagram</i>
1.	<p>Drill a 34 mm hole into the left switch panel.</p> <p>Install the user input control dial in the dashboard, aligned so the Enter cap is facing up.</p>	
2.	<p>If the above location is used for a keypad. Install the user control below the override switch as shown.</p>	

Table 13: User Input Control Installation



If the M12 screw lock connectors on the display are over tightened it will twist the connector pins attaching the connector to the PCB. See Appendix A: Attaching Display Connectors on page 48 for the correct method of attaching to the display connectors.



# Can Cabin Interface Module (CCIM)

The CCIM connects the system into the machine electronics.



<i>Step</i>	<i>Description</i>	<i>Diagram</i>
1.	<p>Position the backup battery on top of the CCIM using double sided velcro tape.</p> <p>Position the CCIM on the plate above the steering column using double sided velcro tape.</p> <p>Remove the battery and CCIM from the velcro to allow the connections to be completed. Reattach to the velcro in the section Finalisation on page 39.</p>	 <p>View from the from the floor of the cabin towards the steering column</p>

Table 14: CCIM Installation



# Machine Connections

The following procedures connect the safety systems to the existing electronics in the machine.

 Isolate the main battery before starting the machine connections

 After completing the machine connections the boom can not be moved until the installation is complete

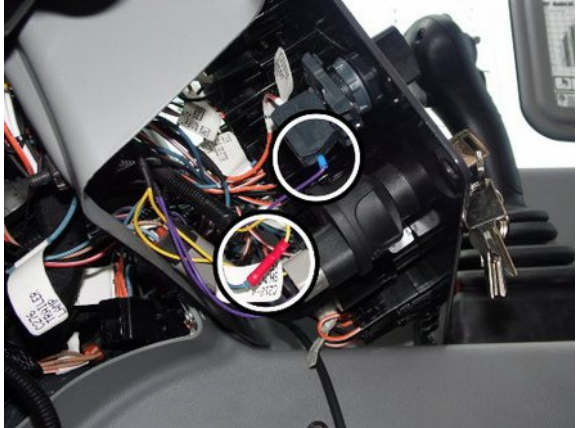
<i>Step</i>	<i>Description</i>	<i>Diagram</i>								
1.	<p>Remove a blanking switch plate from the removable dashboard panel and install the camera switch.</p> <p>Connect the male spade connections from the machine input harness to the camera switch according to the table below.</p> <table border="1"> <thead> <tr> <th><u>Wire Colour</u></th> <th><u>Terminal</u></th> </tr> </thead> <tbody> <tr> <td>Blue</td> <td>1</td> </tr> <tr> <td>Black</td> <td>2</td> </tr> <tr> <td>Green</td> <td>3</td> </tr> </tbody> </table>	<u>Wire Colour</u>	<u>Terminal</u>	Blue	1	Black	2	Green	3	
<u>Wire Colour</u>	<u>Terminal</u>									
Blue	1									
Black	2									
Green	3									

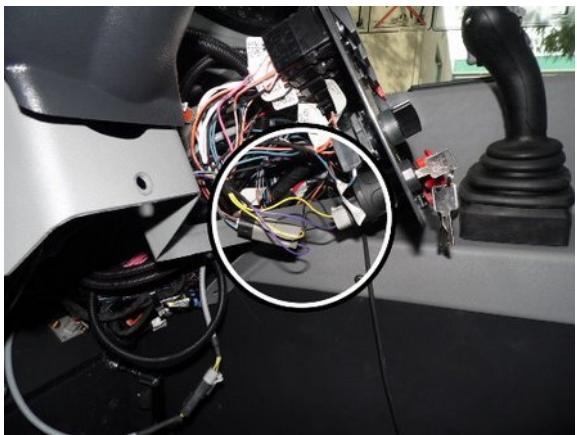
<i>Step</i>	<i>Description</i>	<i>Diagram</i>
2.	<p>Locate the override switch terminal C218 in the removable dashboard panel.</p> <p>Remove the fork terminal connected to blue wire #3310 from the override switch terminal and replace with the violet wire from the machine input harness.</p> <p>Cut off the fork terminal on the blue wire #3310 and join to the yellow wire from the machine input harness.</p>	 <p>View behind the dashboard</p>
3.	<p>Locate the ground lug near the bulkhead connectors attached to the side of the chassis.</p> <p>Attach the ring lug from the machine input harness to the ground lug.</p>	 <p>View from the from the floor of the cabin towards the middle of the machine</p>
4.	<p>Locate the ignition key switch terminal C210 in the removable dashboard panel.</p> <p>Connect the 6 pin tee connection on the power harness into the C210 connector.</p>	 <p>View behind the dashboard</p>

<i>Step</i>	<i>Description</i>	<i>Diagram</i>
5.	Attach the ring lug from the power harness to the ground lug, located earlier.	 <p data-bbox="858 645 1412 745">View from the from the floor of the cabin towards the middle of the machine</p>



*Table 15: Machine Connections*

# Cabin Loom



The cabin loom connects the CCIM to the machine connections and the other modules of the system.



Do not disconnect the camera power connection while the system is operating as this can damage the fuse.

<i>Step</i>	<i>Description</i>	<i>Diagram</i>
1.	<p>Connect the CCIM and signal light cables to the M12 connectors on the CCIM.</p> <p>Note: It doesn't which of the M12 connectors the CCIM and signal light cables are plugged into.</p>	
2.	<p>Connect the power/camera and IO harnesses to the CCIM bulk head connectors</p>	
3.	<p>Connect the forward and reverse cables to the power/camera harness.</p> <p>Note; The white connector is not used.</p>	



<i>Step</i>	<i>Description</i>	<i>Diagram</i>
4.	<p>Connect the 4 pin connector from the machine input harness into the IO harness.</p> <p>Connect the 6 pin connector from the machine cutout harness to the IO harness.</p> <p>Connect the 12 pin connector from the lock pin release harness to the IO harness.</p> <p>Note: The 2 pin connection on the IO harness is not used.</p>	
5.	<p>Run the 8 pin CCIM cable and the 5 pin user control cable through the gap between the window and the dashboard.</p> <p>Note: The clip-on ferrites will need to be removed to run the cables through the gap between the window and the dashboard. Reattach the ferrites according to Appendix A: Attaching Display Connectors on page 48.</p>	
6.	<p>Run the cables through snake tube.</p> <p>Place cable tie points on the side of the window.</p> <p>Cable tie the snake tube to the cable tie points.</p> <p>Connect into the 8 pin and 5 pin connectors into the display</p>	

<i>Step</i>	<i>Description</i>	<i>Diagram</i>
7.	<p>Connect the spade lug on the black wire to the negative (black) battery terminal on the backup battery.</p> <p>Connect the spade lug on the blue wire to the positive (red) battery terminal on the backup battery.</p>	

Table 16: Cabin Loom Installation





If the M12 screw lock connectors on the display are over tightened it will twist the connector pins attaching the connector to the PCB. See Appendix A: Attaching Display Connectors on page 48 for the correct method of attaching to the display connectors.





If the clip-on ferrites were removed from the CCIM and user control cables. See Appendix B: Reattach Ferrites and page 52 for the correct reattachment position.

# Finalisation

This section will complete the final power connections to power the system and finish any additional items.

<i>Step</i>	<i>Description</i>	<i>Diagram</i>
1.	<p>Connect the 3 pin connector from the radio power harness into the power/camera harness.</p> <p>Coil up and store the wire harnesses under the dashboard.</p>	
2.	<p>Attach the backup battery to the velcro on the CCIM and attach the CCIM to the velcro installed earlier to the cabin chassis</p>	 <p data-bbox="858 1352 1410 1417">View from the from the floor of the cabin towards the steering column</p>

<i>Step</i>	<i>Description</i>	<i>Diagram</i>
3.	Reconnect the tee connectors back into the spool assembly and the lock pin release solenoids.	 <p data-bbox="858 645 1378 712">View from under the cylinder towards the solenoid connections</p> 
4.	<p data-bbox="309 1191 839 1303">Turn the machine onto first stage /accessories and ensure the system is activated.</p> <p data-bbox="309 1339 772 1415">Adjust the display bracket for optimal viewing</p> <p data-bbox="309 1451 839 1630">Press the top of the Camera switch to activate the forward camera. Adjust the forward camera so the front right wheel is visible.</p> <p data-bbox="309 1666 807 1809">Press the bottom of the Camera switch to activate the reverse camera. Adjust the reverse camera so the video is level.</p>	





<i>Step</i>	<i>Description</i>	<i>Diagram</i>
5.	<p>Operate the boom movement controls to test if a false N07 fault occurs.</p> <p>If a N07 fault does occur, adjust the arm on the stow switch forwards towards the stow switch trigger.</p> <p>Note: The actual switch arm orientation may differ from the picture.</p>	
6.	<p>Perform a final check on all the cabling and sensors.</p> <p>Replace all the covers</p>	

Table 17: Finalisation



Complete the system checklist once installation has been completed.

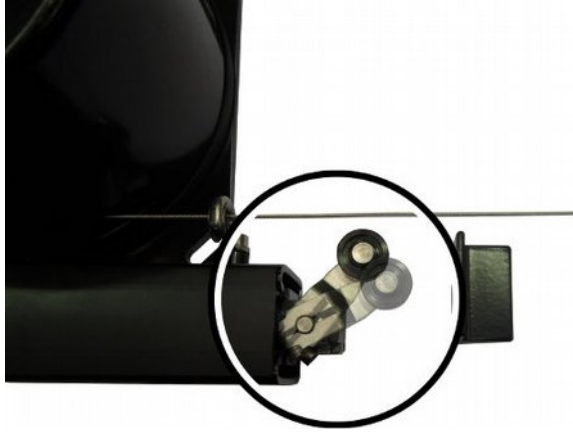

# Set Time & Sensor Calibration

Once the installation is complete, the time will need to be set and the sensors will require calibration.



A sensor calibration must be performed once the cable reeler and CPIM have been mounted. If the cable reeler or CPIM have been moved/repositioned a recalibration must be performed

<i>Step</i>	<i>Description</i>	<i>Diagram</i>
1.	<p>Press Enter on the user control dial to enter the menu system.</p> <p>Press the arrow buttons to select System Menu.</p> <p>Press Enter to select the menu.</p>	<div style="border: 1px solid black; padding: 5px;"> <p style="margin: 0;">Main Menu</p> <hr/> <p style="margin: 0;">Attachment Selection Menu</p> <div style="background-color: #4a7ebb; color: white; padding: 5px; text-align: center; margin: 5px 0;">System Menu</div> <p style="margin: 0;">Exit Menu</p> <hr/> </div>
2.	Select Advanced Menu	<div style="border: 1px solid black; padding: 5px;"> <p style="margin: 0;">System Menu</p> <hr/> <p style="margin: 0;">Volume / Brightness</p> <hr/> <p style="margin: 0;">Status Menu</p> <hr/> <p style="margin: 0;">Diagnostics Menu</p> <hr/> <p style="margin: 0;">System Tests</p> <div style="background-color: #4a7ebb; color: white; padding: 5px; text-align: center; margin: 5px 0;">Advanced Menu</div> <p style="margin: 0;">Return to Main Menu</p> <hr/> </div>

<i>Step</i>	<i>Description</i>	<i>Diagram</i>														
3.	Enter the password (Default Password: 2-8-4)	<table border="1"> <thead> <tr> <th colspan="2"><i>Enter Password</i></th> </tr> </thead> <tbody> <tr> <td>Number 1</td> <td>2</td> </tr> <tr> <td>Number 2</td> <td>8</td> </tr> <tr> <td>Number 3</td> <td>4</td> </tr> <tr> <td colspan="2"><b>Submit Password</b></td> </tr> <tr> <td colspan="2">Return to System Menu</td> </tr> </tbody> </table>	<i>Enter Password</i>		Number 1	2	Number 2	8	Number 3	4	<b>Submit Password</b>		Return to System Menu			
<i>Enter Password</i>																
Number 1	2															
Number 2	8															
Number 3	4															
<b>Submit Password</b>																
Return to System Menu																
4.	Select Set Time / Date	<table border="1"> <thead> <tr> <th colspan="2"><i>Advanced Settings</i></th> </tr> </thead> <tbody> <tr> <td colspan="2"><b>Set Time / Date</b></td> </tr> <tr> <td colspan="2">Sensor Calibrations</td> </tr> <tr> <td colspan="2">Change Language</td> </tr> <tr> <td colspan="2">Change Password</td> </tr> <tr> <td colspan="2">Return to System Menu</td> </tr> </tbody> </table>	<i>Advanced Settings</i>		<b>Set Time / Date</b>		Sensor Calibrations		Change Language		Change Password		Return to System Menu			
<i>Advanced Settings</i>																
<b>Set Time / Date</b>																
Sensor Calibrations																
Change Language																
Change Password																
Return to System Menu																
5.	<p>Enter the correct time and date for your area.</p> <p>Press the arrow keys to select a time/date parameter</p> <p>Press Enter and the parameter will change to red, press the arrow keys to change the value and then press the Enter key to store the value.</p> <p>Note: The hour parameter is in 24 hour clock</p> <p>Repeat for the rest of the time values</p>	<table border="1"> <thead> <tr> <th colspan="2"><i>Set Time / Date</i></th> </tr> </thead> <tbody> <tr> <td><b>Hour</b></td> <td><b>15</b></td> </tr> <tr> <td>Minute</td> <td>54</td> </tr> <tr> <td>Day</td> <td>10</td> </tr> <tr> <td>Month</td> <td>2</td> </tr> <tr> <td>Year</td> <td>2016</td> </tr> <tr> <td>Region</td> <td>Melbourne</td> </tr> </tbody> </table>	<i>Set Time / Date</i>		<b>Hour</b>	<b>15</b>	Minute	54	Day	10	Month	2	Year	2016	Region	Melbourne
<i>Set Time / Date</i>																
<b>Hour</b>	<b>15</b>															
Minute	54															
Day	10															
Month	2															
Year	2016															
Region	Melbourne															

<i>Step</i>	<i>Description</i>	<i>Diagram</i>
6.	Scroll to the next page and select Save to store the new time/date and return to the Advanced Menu.	<p>The diagram shows a menu with a blue highlighted button labeled "Save" and a text option below it labeled "Return to Advanced Menu".</p>
7.	Select Sensor Calibrations	<p>The diagram shows a menu titled "Advanced Settings" with options: "Set Time / Date", "Sensor Calibrations" (highlighted in blue), "Change Language", "Change Password", and "Return to System Menu".</p>
8.	Select Calibrate Carrier Angle and then follow the instructions on the screen to complete the calibration.  Repeat for Calibrate Boom Angle and Calibrate Boom Length.	<p>The diagram shows a menu titled "Sensor Calibration Menu" with options: "Calibrate Carrier Angle" (highlighted in blue), "Calibrate Boom Angle", "Calibrate Boom Length", and "Return to Advanced Menu".</p>

Table 18: Sensor Calibration

# Schematics

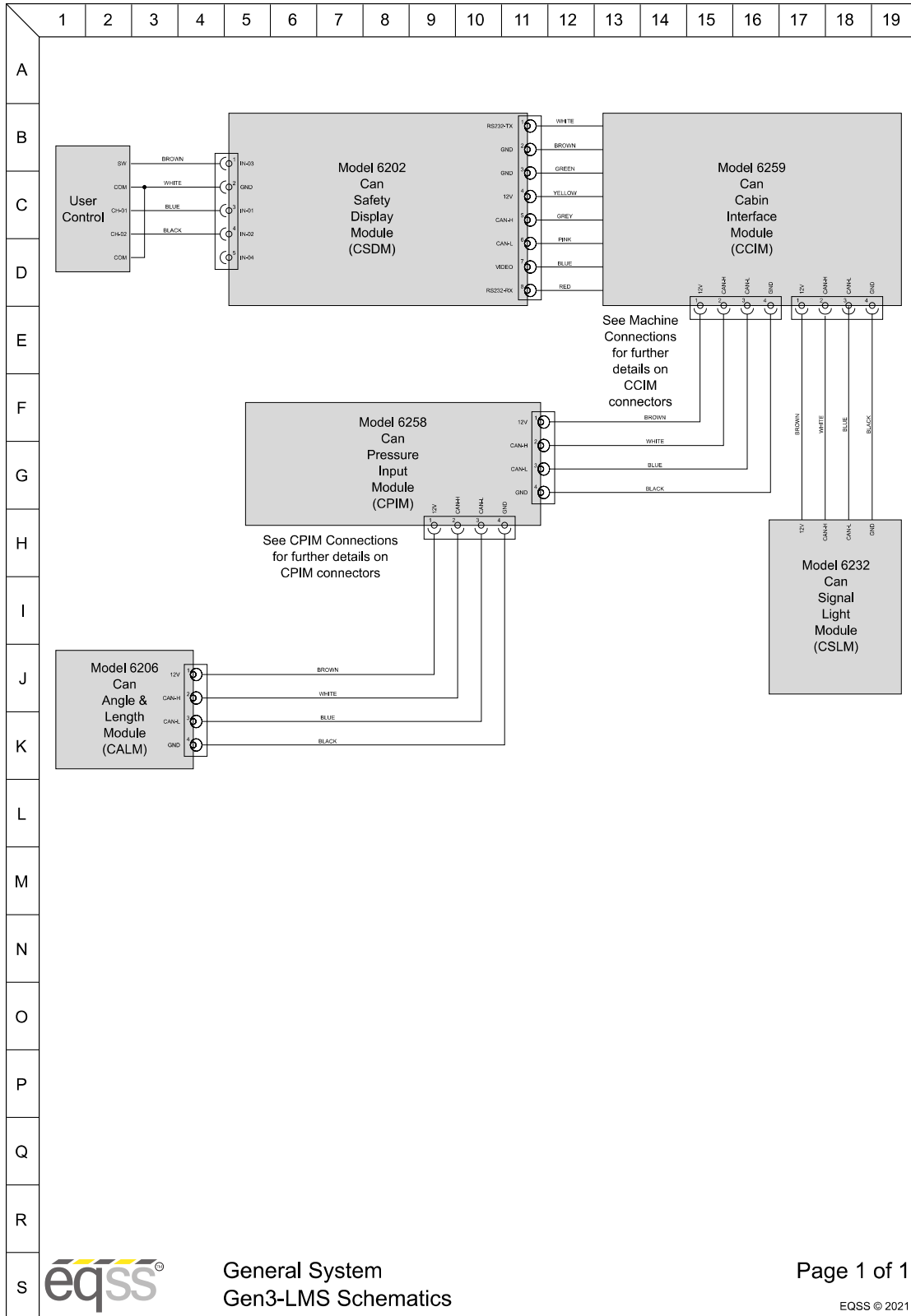

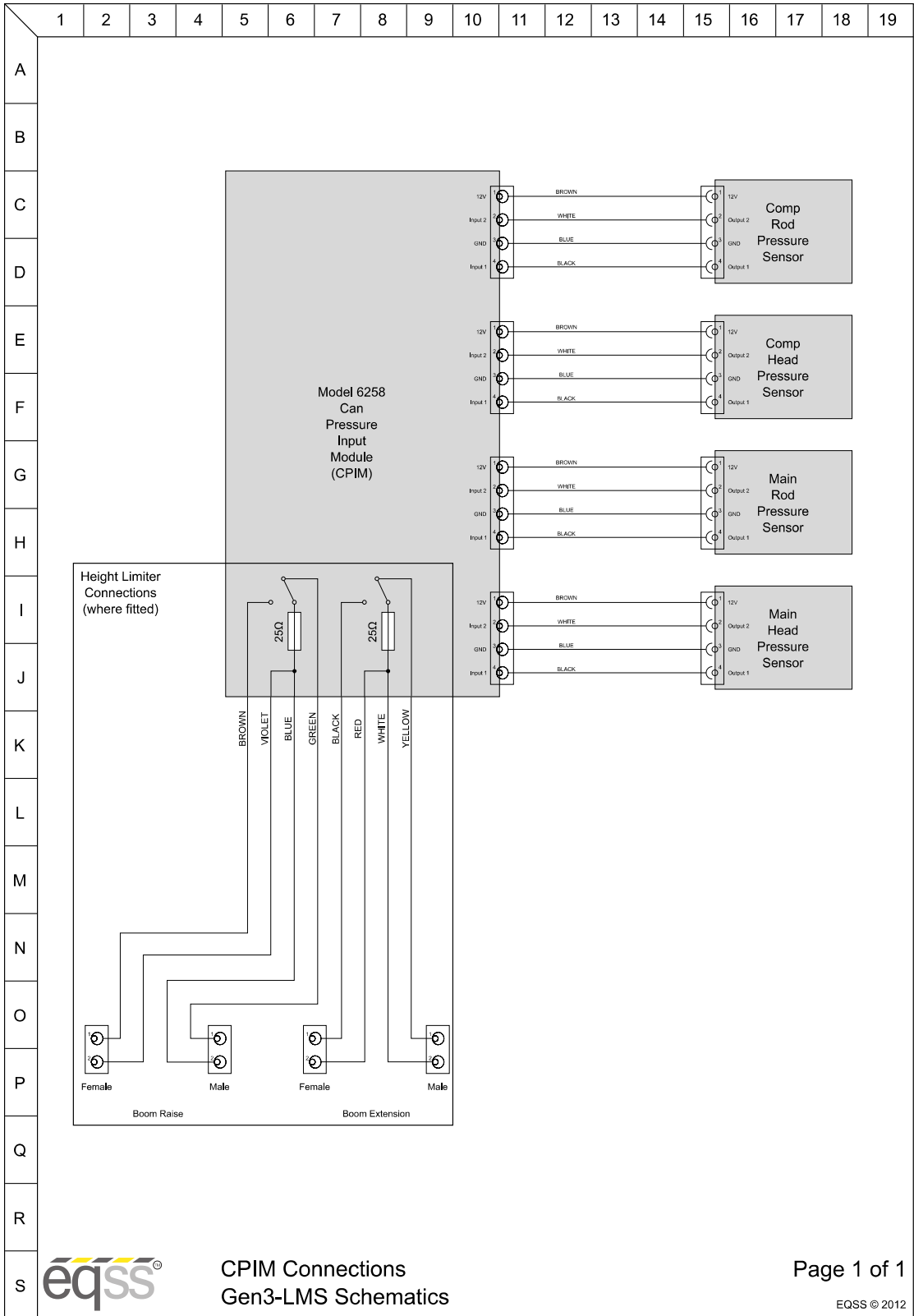



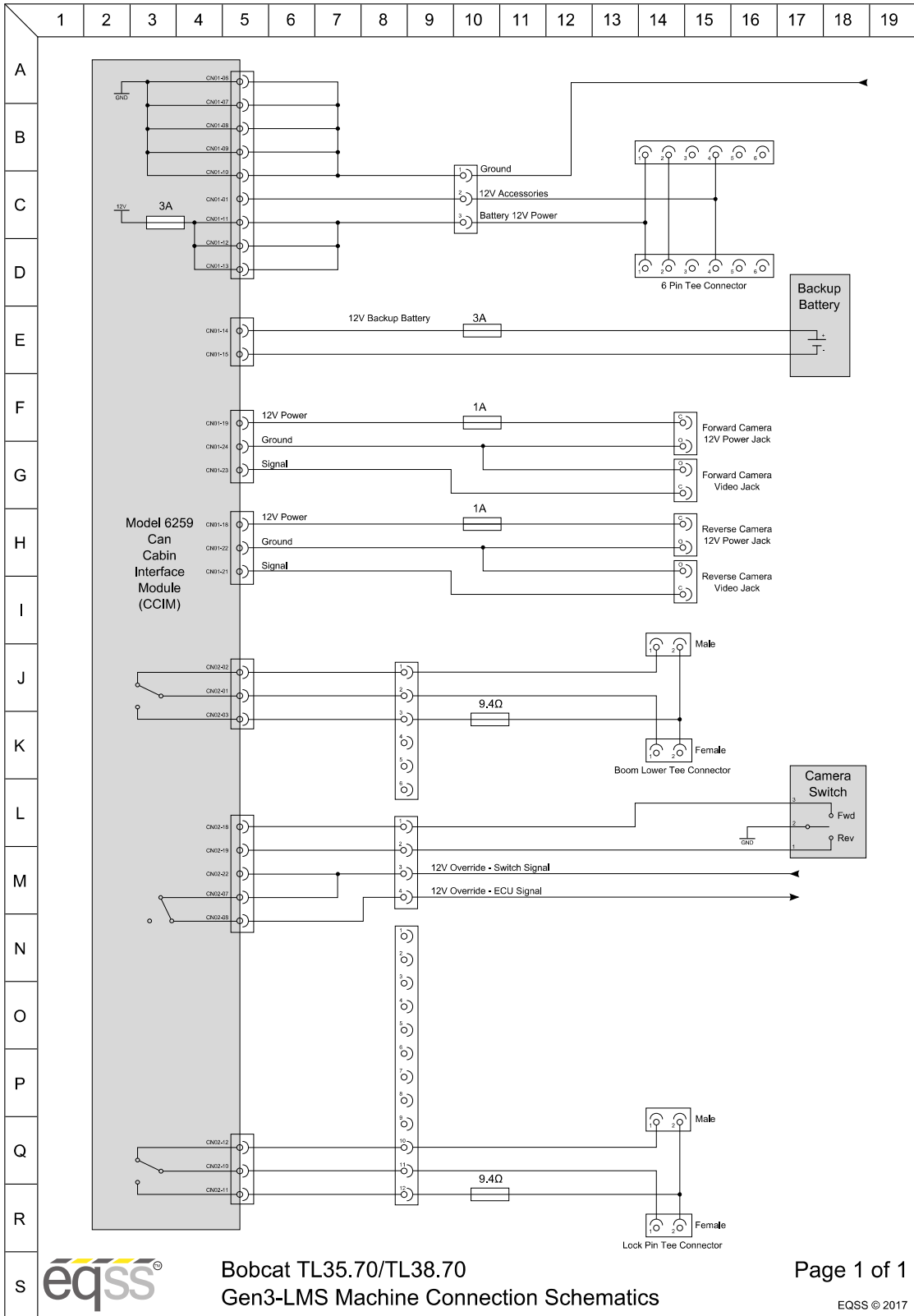

# Appendix A: Attaching Display Connectors

The procedure below describes the correct method of attaching the cables to the screw lock connectors on the display.



If the M12 screw lock connectors on the display are over tightened, it will twist the connector pins attaching the connector to the PCB.

<i>Step</i>	<i>Description</i>	<i>Diagram</i>
1.	<p>Connect the cable from the user control to the top 5 pin connector on the display.</p> <p>Connect the cable from the CCIM to the bottom 8 pin connector on the display.</p>	
2.	<p>Line up the alignment hole on the cable connector with the alignment notch on the display connector.</p>	



<i>Step</i>	<i>Description</i>	<i>Diagram</i>
3.	Push the female connector from the cable into the male connector on the display.	
4.	Rotate the nut on the female connector by hand in a clockwise direction, until the tension on the nut starts to increase.	
5.	Push the cable in again and repeat steps 3 and 4 until the connector is secure.	

Table 19: Install Display Connector Procedure



The method to correctly secure the cable is to push-twist-push-twist until the connector is fully inserted and secure. This will minimise the twisting force applied to the connector.

Below is a picture of a damaged connector on the PCB inside the display. This damaged occurred because the connector was over tightened.

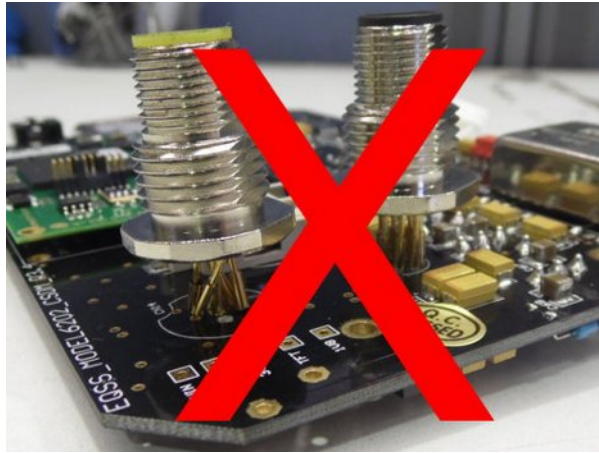

*Illustration 4: Damaged Display Connector*



Do not use any tools to tighten the connector.



*Illustration 5: Do Not Use Tools To Tighten Connector*



Do not over-tighten the nuts on the back of the display connectors. These nuts should only be hand tightened. If the nuts are overtightened it will damage the PCB inside the display.



*Illustration 6: Do Not Over Tighten Nuts*



Damage to the display connectors is not covered under warranty.



# Appendix B: Reattach Ferrites

If the clip-on ferrites on the displays are removed during installation, they will need to be reattached as shown in the procedure below.

 If the ferrites are not reinstalled or attached in the specified location the Gen3-LMS kit will not meet the AS/NZS CISPR 22:2006 certification.

<i>Step</i>	<i>Description</i>	<i>Diagram</i>
1.	<p>Attach the two clip-on ferrites at a location of 60 mm and 260 mm from the start of the connector to the start of the ferrite.</p> <p>Do this for both the CCIM and user control cables that plug into the display.</p>	

Table 20: Reattach Ferrites Procedure

# Indexes and Tables

## Illustration Index

Illustration 1: Machine Boom.....	7
Illustration 2: Machine Chassis.....	8
Illustration 3: Cable Reeler Mounting Position.....	13
Illustration 4: Damaged Display Connector.....	50
Illustration 5: Do Not Use Tools To Tighten Connector.....	50
Illustration 6: Do Not Over Tighten Nuts.....	51

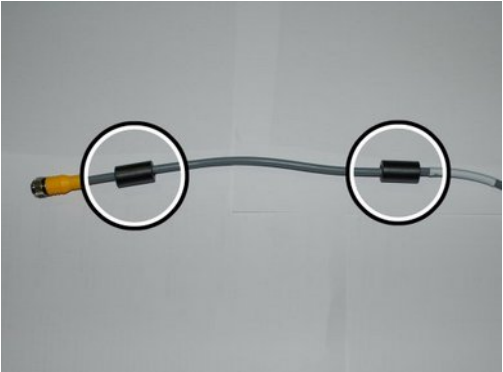
## Index of Tables

Table 1: Component Installation Index.....	6
Table 2: Cable Installation Index.....	6
Table 3: Cover removal.....	10
Table 4: Cable Reeler Installation.....	12
Table 5: Pressure Sensor Installation.....	15
Table 6: Compensation Pressure Sensor Installation.....	17
Table 7: Reverse Camera Installation.....	18
Table 8: Can Pressure Input Module (CPIM) Installation.....	20
Table 9: Signal Light Installation.....	22
Table 10: Forward Camera Installation.....	23
Table 11: External Cable Completion.....	28
Table 12: Display Installation.....	29
Table 13: User Input Control Installation.....	31
Table 14: CCIM Installation.....	32
Table 15: Machine Connections.....	35
Table 16: Cabin Loom Installation.....	38
Table 17: Finalisation.....	41
Table 18: Sensor Calibration.....	44
Table 19: Install Display Connector Procedure.....	49
Table 20: Reattach Ferrites Procedure.....	52

---

**Equipment Safety Systems Pty. Ltd.** ABN: 31 061 789 151  
27 Cumberland Drive, Seaford 3198, Victoria, Australia

Tel: +61 3 8770 6555  
Fax: +61 3 8770 6590  
Web: [www.eqss.com.au](http://www.eqss.com.au)