



# eqss™ Gen-3 LMS Telehandler Load Management System

## Installation Manual for TL30.60 – 2025 Model



**\*\*\*Do Not Swap Components between Gen3-LMS kits\*\*\***

**When installing multiple Gen3-LMS kits, make sure the serial number on the sticker matches the serial number on the machine.**

**\*\*\*Failure To Follow Installation Manual Will Void Warranty\*\*\***

## Documentation Conventions

The list below highlights important documentation conventions.



Text presented in this manner is intended to provide the user with some general information. The user should ensure information presented in this manner is clearly understood.



Text presented in this manner provides the user with information to assist in completion of the current procedure being explained.



Text presented in this manner indicates that a failure to follow directions could result in damage to equipment, loss of information, bodily harm, or loss of life.

## **Important Information**

Information contained in this publication regarding this device's applications and the like is provided only for your convenience and may be superseded by updates. It is your responsibility to ensure that the application or our equipment meets with your specifications.

EQUIPMENT SAFETY SYSTEMS MAKE NO REPRESENTATIONS OR WARRANTIES OF ANY KIND WHETHER EXPRESS OR IMPLIED, WRITTEN OR ORAL, STATUTORY OR OTHERWISE, RELATED TO THE INFORMATION, INCLUDING BUT NOT LIMITED TO, IT'S CONDITION, QUALITY, PERFORMANCE, MERCHANTABILITY OR FITNESS FOR PURPOSE.

Equipment Safety Systems disclaims all liability arising from this information and its use. Use of Equipment Safety Systems' products as critical components in life support systems is not authorised except with express written approval by Equipment Safety Systems. No licenses are conveyed, implicitly or otherwise, under any Equipment Safety Systems intellectual property rights.

# Table of Contents

Tools Required for Installation.....	5
Installation Index.....	6
Covers.....	10
Cable Reeler Installation.....	13
Cable Reeler Mounting Position.....	15
Pressure Sensor Installation.....	16
Main Cylinder Pressure Sensors.....	16
Compensation Pressure Sensors.....	18
Can Pressure Input Module (CPIM).....	20
Signal Light Installation.....	22
Forward Camera.....	25
External Cable Completion.....	27
Display Installation.....	31
User Control.....	32
Can Cabin Interface Module (CCIM).....	33
Machine Connections.....	34
Cabin Loom.....	37
Finalisation.....	40
Set Time & Sensor Calibration.....	42
Schematics.....	45
Appendix A: Attaching Display Connectors.....	48
Appendix B: Reattach Ferrites.....	52
Indexes and Tables.....	53

# Tools Required for Installation

The tools required to perform the installation of the TSS are listed below

- Pencil or Texta
- Drill
- Drill bits
  - 3.3 mm
  - 4.5 mm
  - 5 mm
  - 6.8 mm
  - 8.5 mm
- Centre punch
- Tap T-Handle
- Taps
  - M6
  - M8
- Drill and tap oil
- Metric Allen keys
- Phillips Head screw driver
- Spanners and sockets
  - 7 mm
  - 10 mm
  - 13 mm
- Loctite thread locker
- Side cutters
- Stanley knife
- Crimpers
- Wire strippers
- Torque Wrench

# Installation Index

The components and cables of the Gen-3 Telehandler Load Management System are outline in the tables below. The following pages show where the components are installed and the cable routing.

See the appropriate manual section for a detailed installation description for each component.



Refer to this section for any component placement or cable routing issues

<i>Item</i>	<i>Component Description</i>
1	Cable Reeler
2	Main Lift Cylinder Pressure Sensors
3	Compensation Cylinder Pressure Sensors
4	Can Pressure Input Module (CPIM)
5	Cutout Connection
6	Lock Pin Release Connection
7	Forward Camera
8	Signal Light

Table 1: Component Installation Index

<i>Colour</i>	<i>Cable Description</i>
Light Purple	Boom Cable
Dark Green	Main Cylinder Pressure Sensor Cables
Dark Blue	Compensation Cylinder Pressure Sensors Cables
Red	Cutout Harness
Orange	Lock Pin Release Harness
Light Green	Forward Camera Cable
Brown	Signal Light Cable
Dark Purple	CCIM Cable

*Table 2: Cable Installation Index*



*Illustration 1: Machine Boom*



Note: The photo above doesn't show the boom lights and boom light cable that the boom cable is attached to.









*Illustration 2: Machine Chassis*

# Covers

Remove the following covers before starting the installation

<i>Step</i>	<i>Description</i>	<i>Diagram</i>
1.	Remove the cover in front of the cabin behind the front left wheel.	
2.	Remove the cover behind the cabin in front of the rear left wheel and side covers next to the fuel tank.	
3.	Remove the covers underneath the boom	

<i>Step</i>	<i>Description</i>	<i>Diagram</i>
4.	Undo the bolts attaching the dashboard.	
5.	Remove the cover under the dashboard	
6.	Remove the switch panel on the side of the cabin and the joystick panel	
7.	Remove the side cover next to the fuel tank.	

<i>Step</i>	<i>Description</i>	<i>Diagram</i>
8.	Remove the fuel tank top cover.	
9.	Remove the inside cabin roof cover.	

*Table 3: Cover removal*



# Cable Reeler Installation

The cable reeler is used to measure the boom extension to determine the maximum lifting capacity.



A false N07 fault can occur if the boom jumps off the stow switch due to pressurising the hydraulic system and without operating the boom extension control. Ensure the stow switch arm is correctly adjusted to prevent this error.

<i>Step</i>	<i>Description</i>	<i>Diagram</i>
1.	<p>Drill the holes for the cable reeler mounting plate according to the mounting diagram on page 15.</p> <p>Mount using the supplied M8 x 30 mm bolts, nuts and washers.</p>	
2.	<p>Drill and tap an M8 hole for the cable anchor. Ensure the cable anchor is positioned so the cable runs in line with the boom.</p> <p>Mount the cable anchor and attach the cable.</p>	
3.	<p>Drill and tap the M6 holes for the stow switch trigger bracket.</p> <p>Mount the stow switch trigger bracket using the supplied M6 x 12 mm bolts and washers.</p> <p>Adjust the length of the trigger plate to ensure the stow switch is pressed when the boom is retracted.</p>	

<i>Step</i>	<i>Description</i>	<i>Diagram</i>
4.	Connect the supplied M12 10 metre cable (CB001027) into the cable reeler connection.	
5.	<p>Run the cable under the boom and cable tie to the existing cable for the boom lights every 500 mm down the boom.</p> <p>Cable tie to the flexible hydraulic hoses down to the chassis. Make sure the cable isn't pinched or stretched when the boom is raised or lowered.</p> <p>Cable tie with the other cables during External Cable Completion on page 27.</p>	

*Table 4: Cable Reeler Installation*

 For further details on running the boom cable refer to the Installation Index on page 6

# Cable Reeler Mounting Position

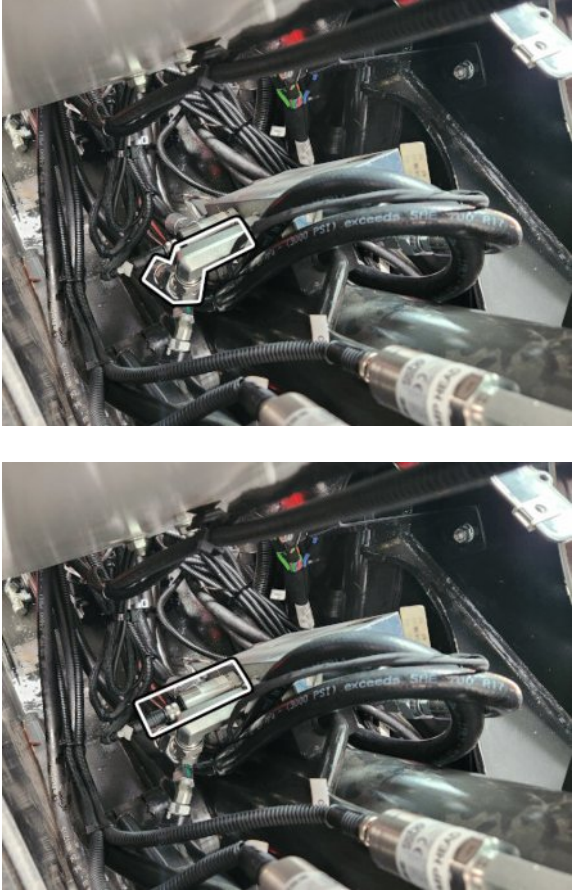
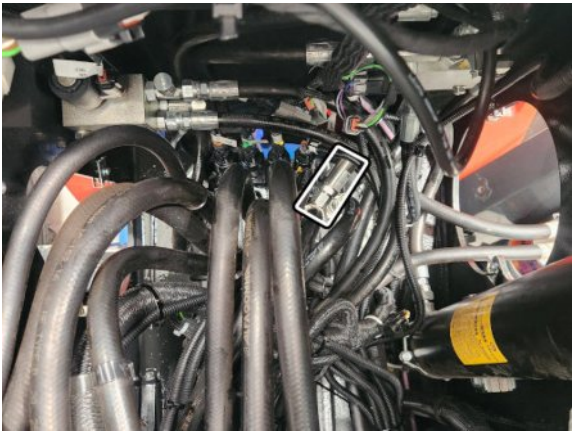

Illustration 3: Cable Reeler Mounting Position

# Pressure Sensor Installation

The hydraulic pressure sensors are used to measure the lifting load of the telehandler.

## Main Cylinder Pressure Sensors

<i>Step</i>	<i>Description</i>	<i>Diagram</i>
1.	<p>Raise the boom to approximately 40 degrees.</p> <p>Support and secure the boom using an A Frame or similar apparatus. <b>It must support at least 2 tons.</b></p> <p>Apply the handbrake and insert chock under wheels.</p> <p>Release the blanking cap on the side of the manifold highlighted in the image.</p> <p><b>Removing the blanking cap will release the hydraulic pressure which may result in a spray of oil.</b></p> <p>Ensure the rod hydraulic fittings on the manifold at V1 angled at 45 degrees, and attach the supplied elbow(HY001178) to the fittings to provide clearance for the head pressure sensor at port M.</p> <p>Install the supplied head pressure sensor directly to the port M.</p>	
2.	<p>Install the supplied rod pressure sensor to the rod hose coming towards hydraulic cylinder block and ensure it is tightly sealed.</p> <p>Ensure the hydraulic fittings are angled as shown to ensure they don't hit the bottom of the boom at minimum boom angle.</p>	





<i>Step</i>	<i>Description</i>	<i>Diagram</i>
3.	<p>Connect the supplied M12 4 metre cables (CB001026) into each of the pressure sensors.</p> <p>Cable tie the pressure sensor cable to the flexible hydraulic hoses connected to the main lift cylinder. Make sure the cable isn't pinched or stretched when the boom is raised or lowered.</p> <p>Run the cables towards the rear of the machine and cable tie with the other cables during External Cable Completion on page 27.</p> <p><b>Ensure the pressure sensors and cables do not collide with the boom and chassis structures and the cables do not stretch or pinch when the boom is raised and lowered.</b></p>	

Table 5: Pressure Sensor Installation

# Compensation Pressure Sensors

<i>Step</i>	<i>Description</i>	<i>Diagram</i>
1.	<p>Undo the hydraulic connection for the rod compensation into the compensation cylinder.</p> <p>Install the supplied Rod pressure sensor and tee connections and reconnect the flexible hydraulic hose.</p> <p>Ensure the pressure sensor and the hydraulic hose connections are against the side of the chassis, to ensure they don't hit the boom when at lower boom angles.</p>	
2.	<p>Undo the hydraulic connection for the head compensation into the compensation cylinder.</p> <p>Install the supplied Head pressure sensor and tee connections and reconnect the flexible hydraulic hose.</p> <p>Ensure the pressure sensor and the hydraulic hose connections are against the side of the chassis, to ensure they don't hit the boom when at lower boom angles.</p> <p><b>Start the machine, pressurise the boom and check for leaks and check for clearance.</b></p>	

<i>Step</i>	<i>Description</i>	<i>Diagram</i>
3.	<p>Connect the supplied M12 4 metre cables (CB001026) into each of the pressure sensors.</p> <p>Cable tie the rod pressure sensor cable to the flexible hydraulic hoses connected to the main lift cylinder along with the main pressure sensor cables. Make sure the cable isn't pinched or stretched when the boom is raised or lowered.</p> <p>Run the cables towards the rear of the machine and cable tie with the other cables during External Cable Completion on page 27.</p>	

*Table 6: Compensation Pressure Sensor Installation*

# Can Pressure Input Module (CPIM)

The CPIM is responsible for processing the information send from the pressure sensors.



Accidentally swapping the pressure sensor connections will not damage the system.



Do not plug the pressure sensor cable into the far right side boom cable. This will damage the system.

<i>Step</i>	<i>Description</i>	<i>Diagram</i>
1.	<p>The CPIM module is mounted on the inside of the chassis under the boom cover as shown in the location.</p> <p>Place the CPIM module on the inside of the chassis and mark the drill hole location. Ensure the location will allow enough clearance to mount the CPIM and attach the M12 cables at the bottom and sides.</p> <p>Drill two M8 holes through the side of the chassis and mount the CPIM using the supplied bolts.</p>	

Step	Description	Diagram
2.	<p>Connect the cables for the pressure sensors and boom cable to the CPIM according to the picture shown.</p> <p>Note: The CCIM cable will be installed during External Cable Completion on page 27.</p>	
3.	<p>Run the height limiter cable from out the left side of the CPIM to the hydraulic block at the rear of the machine.</p> <p>Connect the tee connector labelled “Raise” from the height limiter cable to the boom raise (bottom left) connector on the hydraulic block and the tee connector labelled “Extend” from the height limiter cable to the boom extend (down second from right) connector on the hydraulic block.</p> <p>Place a single cable tie to hold each cable position then disconnect the tee's from the raise and extend connectors, otherwise the boom will not move.</p> <p>Complete the cable installation during External Cable Completion on page 27.</p>	 <p>Note: The location of the connectors in the picture may not match the machine, check the label on the connector</p>



Table 7: Can Pressure Input Module (CPIM) Installation

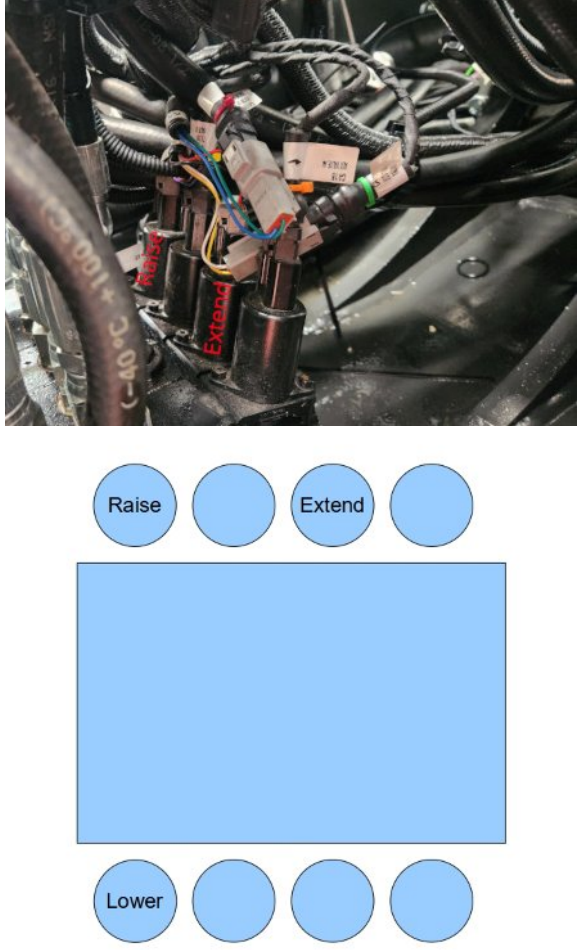

# Signal Light Installation

The signal light warns other workers when the telehandler is lifting loads close to its maximum capacity.



Ensure the power supply voltage is greater than 13.5V otherwise the signal light may not illuminate correctly.

<i>Step</i>	<i>Description</i>	<i>Diagram</i>
1.	Mount the signal light to the top of the cabin using the magnetic anchor.	 <p data-bbox="860 1171 1442 1211">View from on top of the cabin</p>
2.	Inside the cabin, remove the roof cover behind the seat leading to the joystick.	 <p data-bbox="860 1648 1442 1686">View from drivers seat to the roof</p>

<i>Step</i>	<i>Description</i>	<i>Diagram</i>
3.	<p>Cut the signal light cable approximately 300 mm from the end of the M12 connector.</p> <p>Feed the cable through one of the existing grommets for the rotating beacon into the cabin.</p> <p>Note: As an alternative to cutting the cable the grommet hole can be enlarged to fit the M12 connector.</p> <p>Note: The signal light cable must be run through an existing grommet hole. Drilling another hole in the cabin will invalidate the ROPS/FOPS protection of the cabin.</p>	
4.	<p>Run the cable along the same path as the existing cables under the roof cover to the hole for the cable channel down to the chassis.</p>	 <p>View from behind the rear left wheel behind the cabin</p>
5.	<p>Run the cable through the cable channel then out the hole near the fuse panel location (see the circular highlights in the adjacent picture), then follow the existing cable path towards the dashboard and secure using cable ties.</p> <p>Note: Use a cable guide to run the cable through the cable channel</p>	

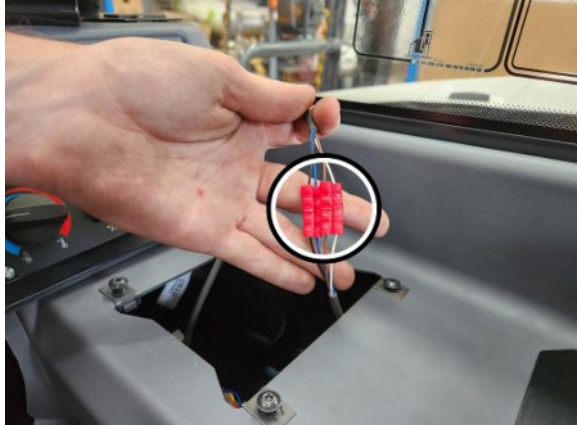
<i>Step</i>	<i>Description</i>	<i>Diagram</i>
6.	<p>Inside the cabin, reconnect the 4 wire cable using the supplied crimp joiners.</p> <p>Secure the joined connections using electrical tape (not shown)</p> <p>Note: The light tower cable will be connected during Finalisation on page 40.</p>	

*Table 8: Signal Light Installation*

# Forward Camera

The forward camera video is displayed on the screen when the machine is in forward gear to allow the operator to see past the boom to obstructions that would damage the right front tyre.



Do not disconnect the camera power connection while the system is operating as this can damage the fuse.

<i>Step</i>	<i>Description</i>	<i>Diagram</i>
1.	<p>Drill two holes to the side post mirror frame to mount the camera.</p> <p>Secure using two M6 nuts.</p>	
2.	<p>Connect the camera power and signal connectors to the supplied 5m camera cable (CB001032).</p> <p>Note; The white connector is not used.</p> <p>Run the cable along the same path as the headlight cable through the headlight post.</p> <p>Run the remainder of the cable towards the cabin following the headlight cable and insert into cabin during External Cable Completion on page 27.</p>	

Table 9: Forward Camera Installation





The camera's viewing angle may need to be adjusted once the system is installed and the display is operational.

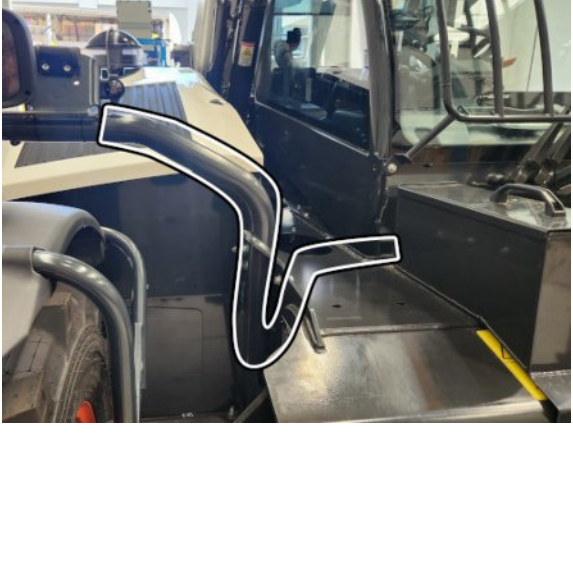

For further details on running the camera cable refer to the Installation Index on page 6

# External Cable Completion

All external cabling is completed in this step.

<i>Step</i>	<i>Description</i>	<i>Diagram</i>
1.	Locate the cable entrance hole from the inside of the cabin to the outside of the chassis, located inside the dashboard to outside the front of the cabin.	 <p data-bbox="858 875 1342 943">View from behind the front left wheel towards the cabin</p>
2.	Run the connector pairs from the cutout and lock pin release harnesses through the connector hole from inside the cabin to the outside of the chassis.	
3.	Connect the supplied M12 4 metre cable (CB001026) into the right side of the CPIM for the CCIM cable.	

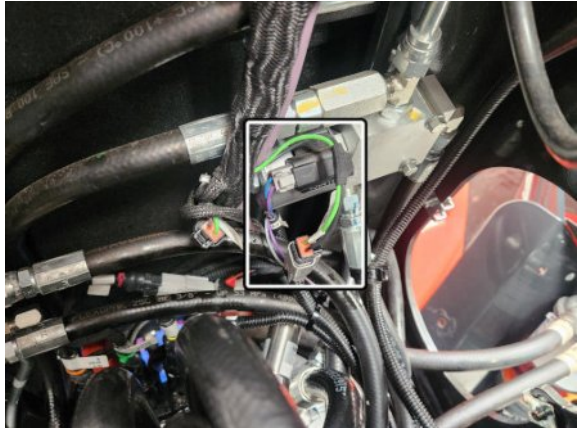
<i>Step</i>	<i>Description</i>	<i>Diagram</i>
4.	<p>Run the cutout and lock pin release harnesses along the same path under the chassis covers as the existing electrical harnesses towards the spool assembly at the rear of the machine.</p> <p>Run the CCIM cable along the same path as the existing electrical harnesses and through the hole into the cabin.</p>	
5.	<p>Run the two pin connectors on the lock pin release harness up to the connection to the cable running up through the boom and secure in place using cable ties.</p> <p>This will be connected during Finalisation on page 40.</p>	 <p data-bbox="858 1084 1437 1120">View from rear of machine</p>

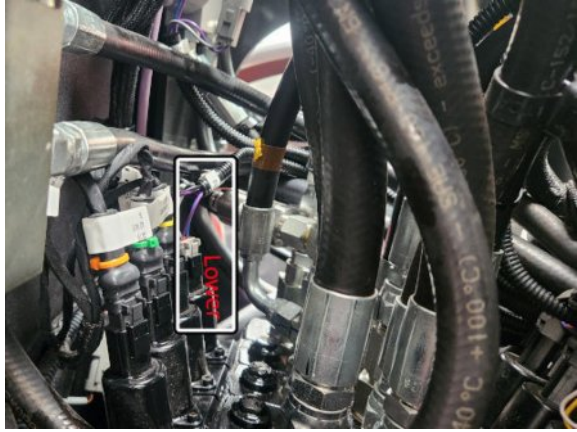
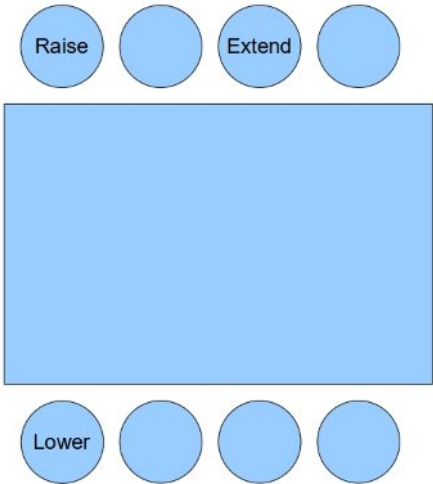
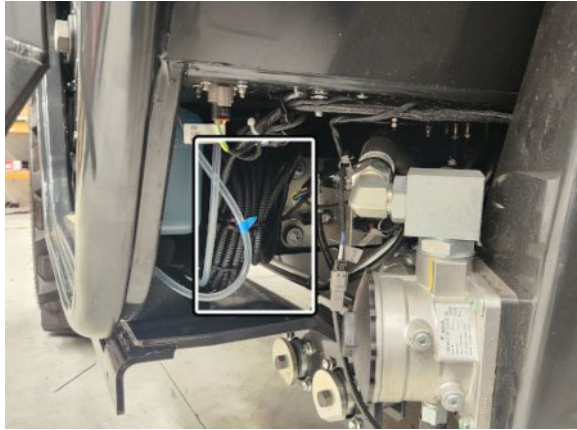
<i>Step</i>	<i>Description</i>	<i>Diagram</i>
<p>6.</p> <p>Run the two pin connectors on the cutout harness down to the boom lower connector on the hydraulic block and secure in place using cable ties.</p> <p>This will be connected during Finalisation on page 40.</p>		  <p>Note: The location of the connectors in the picture above may not match the machine, check the label on the connector</p>
<p>7.</p> <p>Coil up the additional cabling for the pressure sensor, CCIM and boom cables and store under the cabin.</p>		 <p>View from behind the cabin</p>

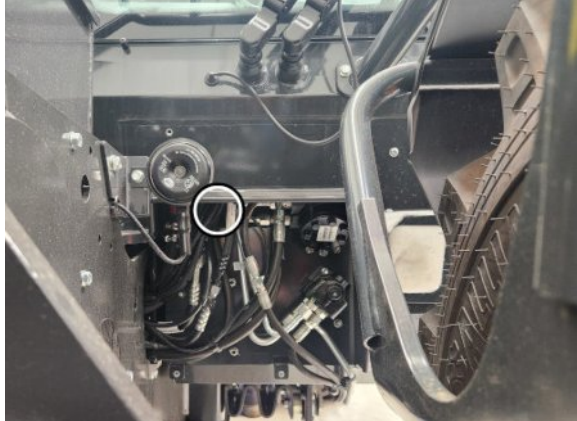
<i>Step</i>	<i>Description</i>	<i>Diagram</i>
8.	<p>Run the CCIM and camera cable up through the hole into the cabin.</p> <p>Note: Pull a short length of cable through into the cabin. Store excess cable under the cabin.</p>	

*Table 10: External Cable Completion*

# Display Installation

The display shows the current safety status of the telehandler.

<i>Step</i>	<i>Description</i>	<i>Diagram</i>
1.	Remove the rear mirror from the right column.  Use the existing bolts to mount the display adaptor bracket to the rear mirror mount.	

Table 11: Display Installation



Adjust the display bracket for optimal viewing angle once the display is powered



If the M12 screw lock connectors on the display are over tightened it will twist the connector pins attaching the connector to the PCB. See Appendix A: Attaching Display Connectors on page 48 for the correct method of attaching to the display connectors.

# User Control

The user control consists of a single dial switch mounted in the dashboard.

<i>Step</i>	<i>Description</i>	<i>Diagram</i>
1.	<p>Drill a 39 mm hole into the switch panel below the dashboard as shown.</p> <p>Install the user control dial in the dashboard, aligned so the Enter cap is facing up.</p>	

Table 12: User Control Installation



If the M12 screw lock connectors on the display are over tightened it will twist the connector pins attaching the connector to the PCB. See Appendix A: Attaching Display Connectors on page 48 for the correct method of attaching to the display connectors.

# Can Cabin Interface Module (CCIM)

The CCIM connects the system into the machine electronics.



<i>Step</i>	<i>Description</i>	<i>Diagram</i>
1.	Install the CCIM onto the flat plate under the switch board cover beside the joystick in the location shown.	
2.	Secure in place using velcro tape.  Remove the CCIM from the velcro to allow the connections to be completed. Reattach to the velcro in the section Finalisation on page 40.	

Table 13: CCIM Installation

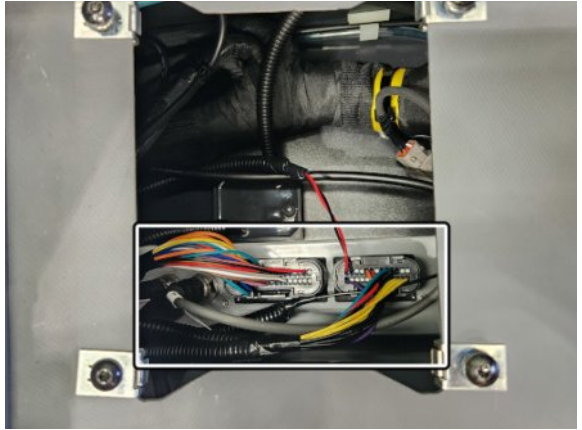

# Machine Connections

The following procedures connect the safety systems to the existing electronics in the machine.

 Isolate the main battery before starting the machine connections

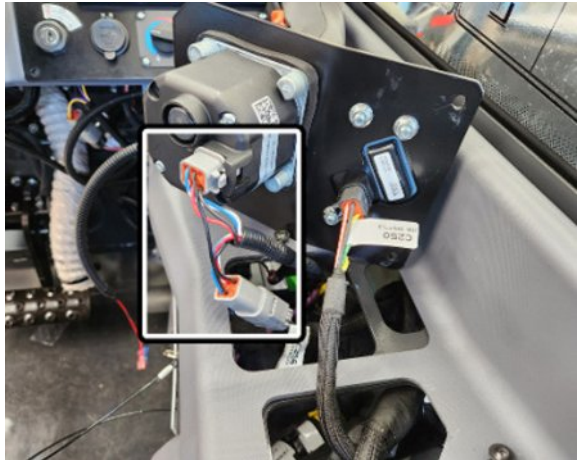
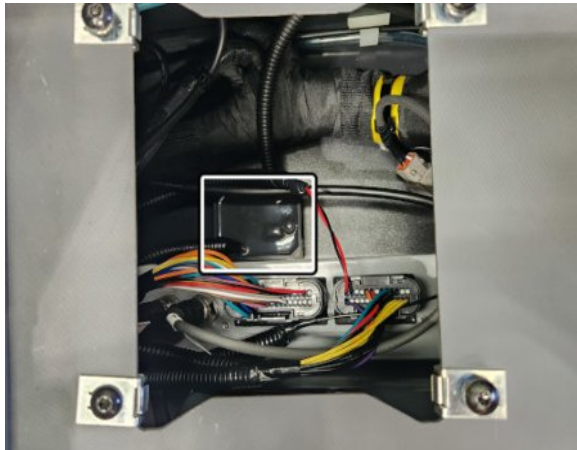
 After completing the machine connections the boom can not be moved until the installation is complete

<i>Step</i>	<i>Description</i>	<i>Diagram</i>
1.	<p>Remove the plate holding the joystick.</p> <p>Connect the 6 pin tee connectors from the CAN I/O module harness into the joystick connector C256.</p>	
2.	<p>Secure the CAN I/O module onto the flat plate under the switch board cover next to the CCIM module using velcro tape.</p>	

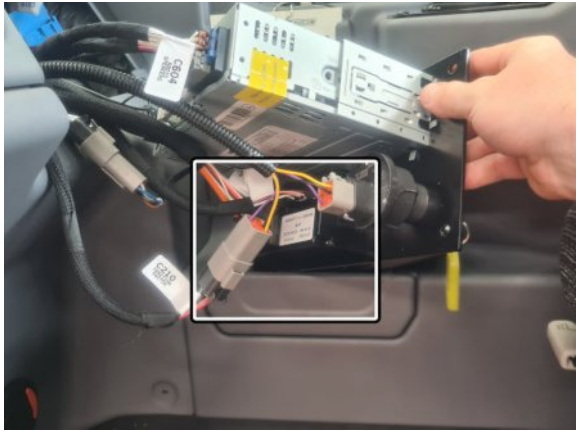
<i>Step</i>	<i>Description</i>	<i>Diagram</i>
3.	Locate connector C234 in the set of connectors on the harness running to the steering wheel switches under the dashboard panel.	
4.	<p>Cut the blue wire #3310 and join the violet wire from the CAN I/O module to the wire running to the steering wheel switches.</p> <p>Join the other side of the wire to the yellow wire from the CAN I/O module.</p> <p>Secure the wire joins with electrical tape.</p>	 <p>View behind the dashboard</p> <p>Note: The picture above doesn't show the electrical tape.</p>
5.	<p>Locate the ignition key switch terminal C210 in the removable dashboard panel.</p> <p>Connect the 6 pin tee connection on the power harness into the C210 connector.</p>	 <p>View behind dashboard panel</p>

<i>Step</i>	<i>Description</i>	<i>Diagram</i>
6.	Connect the male spade terminal from the power harness to the female spade terminal on the CAN I/O module harness for the ground connection.	 <p data-bbox="858 645 1439 719">View from under the joystick plate cover.</p>

*Table 14: Machine Connections*

# Cabin Loom

The cabin loom connects the CCIM to the machine connections and the other modules of the system.

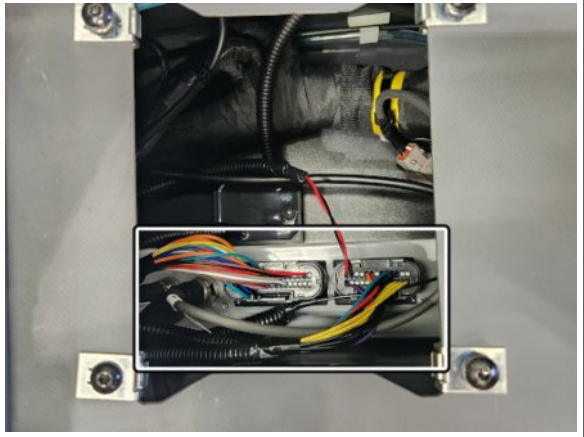
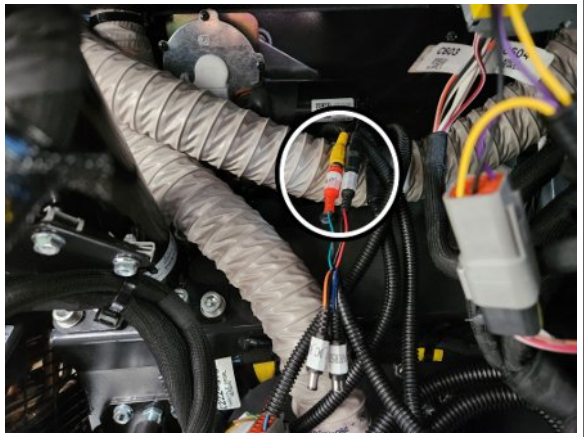

Do not disconnect the camera power connection while the system is operating as this can damage the fuse.

<i>Step</i>	<i>Description</i>	<i>Diagram</i>
1.	<p>Connect the CCIM and signal light cables to the M12 connectors on the CCIM.</p> <p>Note: It doesn't matter which of the M12 connectors the CCIM and signal light cables are plugged into.</p>	
2.	<p>Connect the power/camera and IO harnesses to the CCIM bulk head connectors</p>	
3.	<p>Connect the forward camera cable to the power/camera harness.</p> <p>Note; The rear camera connections are not used and the white connector is not used.</p>	





Step	Description	Diagram
4.	<p>Connect the 2 pin connector from the CAN I/O module harness into the IO harness.</p> <p>Connect the 4 pin connector from the CAN I/O module harness into the IO harness.</p> <p>Connect the 6 pin connector from the machine cutout harness to the IO harness.</p> <p>Connect the 12 pin connector from the lock pin release harness to the IO harness.</p>	
5.	<p>Run the 8 pin CCIM cable and the 5 pin user control cable through the gap between the window and the dashboard.</p> <p>Note: The clip-on ferrites will need to be removed to run the cables through the gap between the window and the dashboard. Reattach the ferrites according to <a href="#">Appendix A: Attaching Display Connectors</a> on page 51.</p>	
6.	<p>Run the cables through snake tube.</p> <p>Cable tie to the tube running to the LMI.</p> <p>Connect into the 8 pin and 5 pin connectors into the display</p>	

Table 15: Cabin Loom Installation



If the M12 screw lock connectors on the display are over tightened it will twist the connector pins attaching the connector to the PCB. See [Appendix A: Attaching Display Connectors](#) on page 51 for the correct method of attaching to the display connectors.



If the clip-on ferrites were removed from the CCIM and user control cables. See [Appendix B: Reattach Ferrites](#) and page [55](#) for the correct reattachment position.

# Finalisation

This section will complete the final power connections to power the system and finish any additional items.

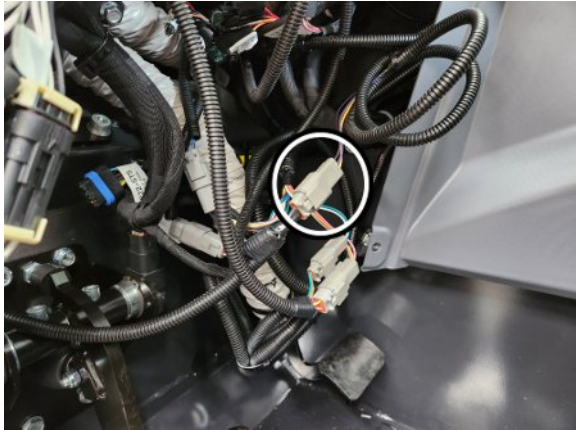
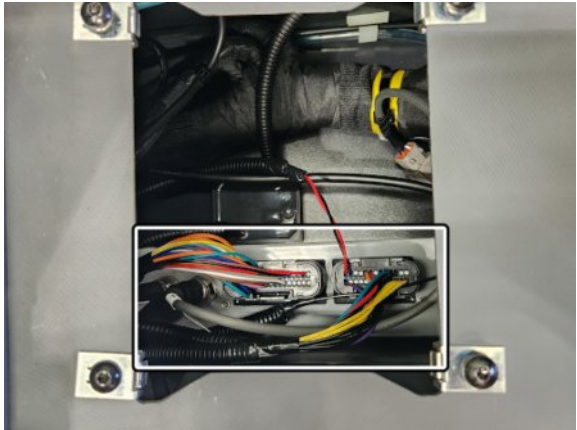
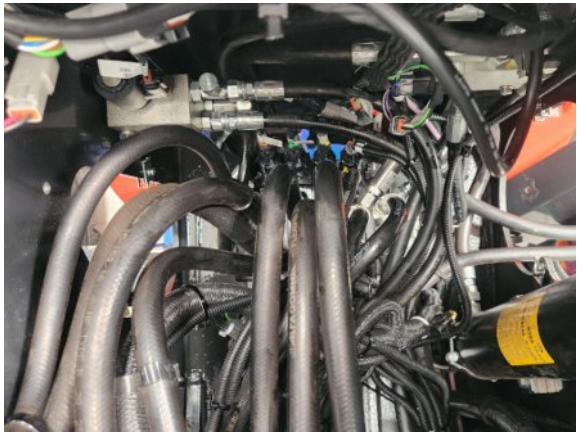
<i>Step</i>	<i>Description</i>	<i>Diagram</i>
1.	<p>Connect the 3 pin connector from the radio power harness into the power/camera harness.</p> <p>Coil up and store the wire harnesses under the dashboard.</p>	
2.	<p>Attach the CCIM to the velcro installed earlier to the cabin chassis.</p>	
3.	<p>Reconnect the tee connectors back into the spool assembly and the lock pin cable through boom connection.</p> <p>Note: Make sure the connections for the cable through boom are placed behind the hydraulic pipes so as not to get crushed against the rear cover once installed.</p>	 <p data-bbox="858 1794 1278 1827">View from rear of machine</p>



<i>Step</i>	<i>Description</i>	<i>Diagram</i>
4.	<p>Turn the machine onto first stage /accessories and ensure the system is activated.</p> <p>Adjust the display bracket for optimal viewing</p> <p>Press the top of the Camera switch to active the forward camera. Adjust the forward camera so the front right wheel is visible.</p>	
5.	<p>Operate the boom movement controls to test if a false N07 fault occurs.</p> <p>If a N07 fault does occur, adjust the arm on the stow switch forwards towards the stow switch trigger.</p> <p>Note: The actual switch arm orientation may differ from the picture.</p>	
6.	<p>Perform a final check on all the cabling and sensors.</p> <p>Replace all the covers</p>	

Table 16: Finalisation

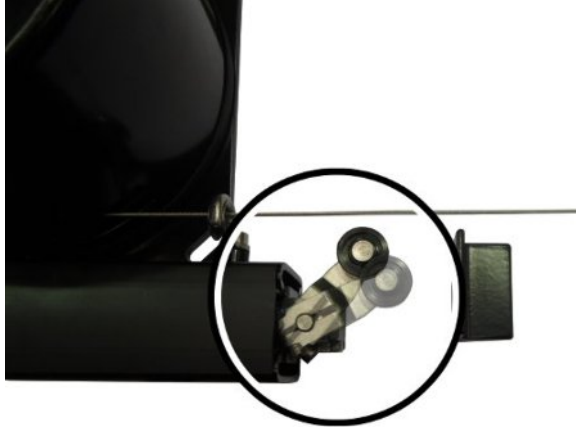

Complete the system checklist once installation has been completed.

# Set Time & Sensor Calibration

Once the installation is complete, the time will need to be set and the sensors will require calibration.



A sensor calibration must be performed once the cable reeler and CPIM have been mounted. If the cable reeler or CPIM have been moved/repositioned a recalibration must be performed

<i>Step</i>	<i>Description</i>	<i>Diagram</i>
1.	<p>Press Enter on the user control dial to enter the menu system.</p> <p>Press the arrow buttons to select System Menu.</p> <p>Press Enter to select the menu.</p>	<div style="border: 1px solid black; padding: 5px;"> <p style="text-align: center; margin: 0;"><small>Main Menu</small></p> <hr/> <p style="text-align: center; margin: 0;">Attachment Selection Menu</p> <div style="background-color: #4a7ebb; color: white; text-align: center; padding: 5px; margin: 5px 0;">System Menu</div> <p style="text-align: center; margin: 0;">Exit Menu</p> <hr/> </div>
2.	Select Advanced Menu	<div style="border: 1px solid black; padding: 5px;"> <p style="text-align: center; margin: 0;"><small>System Menu</small></p> <hr/> <p style="text-align: center; margin: 0;">Volume / Brightness</p> <hr/> <p style="text-align: center; margin: 0;">Status Menu</p> <hr/> <p style="text-align: center; margin: 0;">Diagnostics Menu</p> <hr/> <p style="text-align: center; margin: 0;">System Tests</p> <div style="background-color: #4a7ebb; color: white; text-align: center; padding: 5px; margin: 5px 0;">Advanced Menu</div> <p style="text-align: center; margin: 0;">Return to Main Menu</p> <hr/> </div>

<i>Step</i>	<i>Description</i>	<i>Diagram</i>														
3.	Enter the password (Default Password: 2-8-4)	<table border="1"> <thead> <tr> <th colspan="2"><i>Enter Password</i></th> </tr> </thead> <tbody> <tr> <td>Number 1</td> <td>2</td> </tr> <tr> <td>Number 2</td> <td>8</td> </tr> <tr> <td>Number 3</td> <td>4</td> </tr> <tr> <td colspan="2"><b>Submit Password</b></td> </tr> <tr> <td colspan="2">Return to System Menu</td> </tr> </tbody> </table>	<i>Enter Password</i>		Number 1	2	Number 2	8	Number 3	4	<b>Submit Password</b>		Return to System Menu			
<i>Enter Password</i>																
Number 1	2															
Number 2	8															
Number 3	4															
<b>Submit Password</b>																
Return to System Menu																
4.	Select Set Time / Date	<table border="1"> <thead> <tr> <th colspan="2"><i>Advanced Settings</i></th> </tr> </thead> <tbody> <tr> <td colspan="2"><b>Set Time / Date</b></td> </tr> <tr> <td colspan="2">Sensor Calibrations</td> </tr> <tr> <td colspan="2">Change Language</td> </tr> <tr> <td colspan="2">Change Password</td> </tr> <tr> <td colspan="2">Return to System Menu</td> </tr> </tbody> </table>	<i>Advanced Settings</i>		<b>Set Time / Date</b>		Sensor Calibrations		Change Language		Change Password		Return to System Menu			
<i>Advanced Settings</i>																
<b>Set Time / Date</b>																
Sensor Calibrations																
Change Language																
Change Password																
Return to System Menu																
5.	<p>Enter the correct time and date for your area.</p> <p>Press the arrow keys to select a time/date parameter</p> <p>Press Enter and the parameter will change to red, press the arrow keys to change the value and then press the Enter key to store the value.</p> <p>Note: The hour parameter is in 24 hour clock</p> <p>Repeat for the rest of the time values</p>	<table border="1"> <thead> <tr> <th colspan="2"><i>Set Time / Date</i></th> </tr> </thead> <tbody> <tr> <td><b>Hour</b></td> <td><b>15</b></td> </tr> <tr> <td>Minute</td> <td>54</td> </tr> <tr> <td>Day</td> <td>10</td> </tr> <tr> <td>Month</td> <td>2</td> </tr> <tr> <td>Year</td> <td>2016</td> </tr> <tr> <td>Region</td> <td>Melbourne</td> </tr> </tbody> </table>	<i>Set Time / Date</i>		<b>Hour</b>	<b>15</b>	Minute	54	Day	10	Month	2	Year	2016	Region	Melbourne
<i>Set Time / Date</i>																
<b>Hour</b>	<b>15</b>															
Minute	54															
Day	10															
Month	2															
Year	2016															
Region	Melbourne															

<i>Step</i>	<i>Description</i>	<i>Diagram</i>
6.	Scroll to the next page and select Save to store the new time/date and return to the Advanced Menu.	<p>The diagram shows a menu with two options. The top option is 'Save', which is highlighted in blue. Below it is the option 'Return to Advanced Menu'.</p>
7.	Select Sensor Calibrations	<p>The diagram shows a menu titled 'Advanced Settings'. The options are 'Set Time / Date', 'Sensor Calibrations' (highlighted in blue), 'Change Language', 'Change Password', and 'Return to System Menu'.</p>
8.	Select Calibrate Carrier Angle and then follow the instructions on the screen to complete the calibration.  Repeat for Calibrate Boom Angle and Calibrate Boom Length.	<p>The diagram shows a menu titled 'Sensor Calibration Menu'. The options are 'Calibrate Carrier Angle' (highlighted in blue), 'Calibrate Boom Angle', 'Calibrate Boom Length', and 'Return to Advanced Menu'.</p>

Table 17: Sensor Calibration

# Schematics

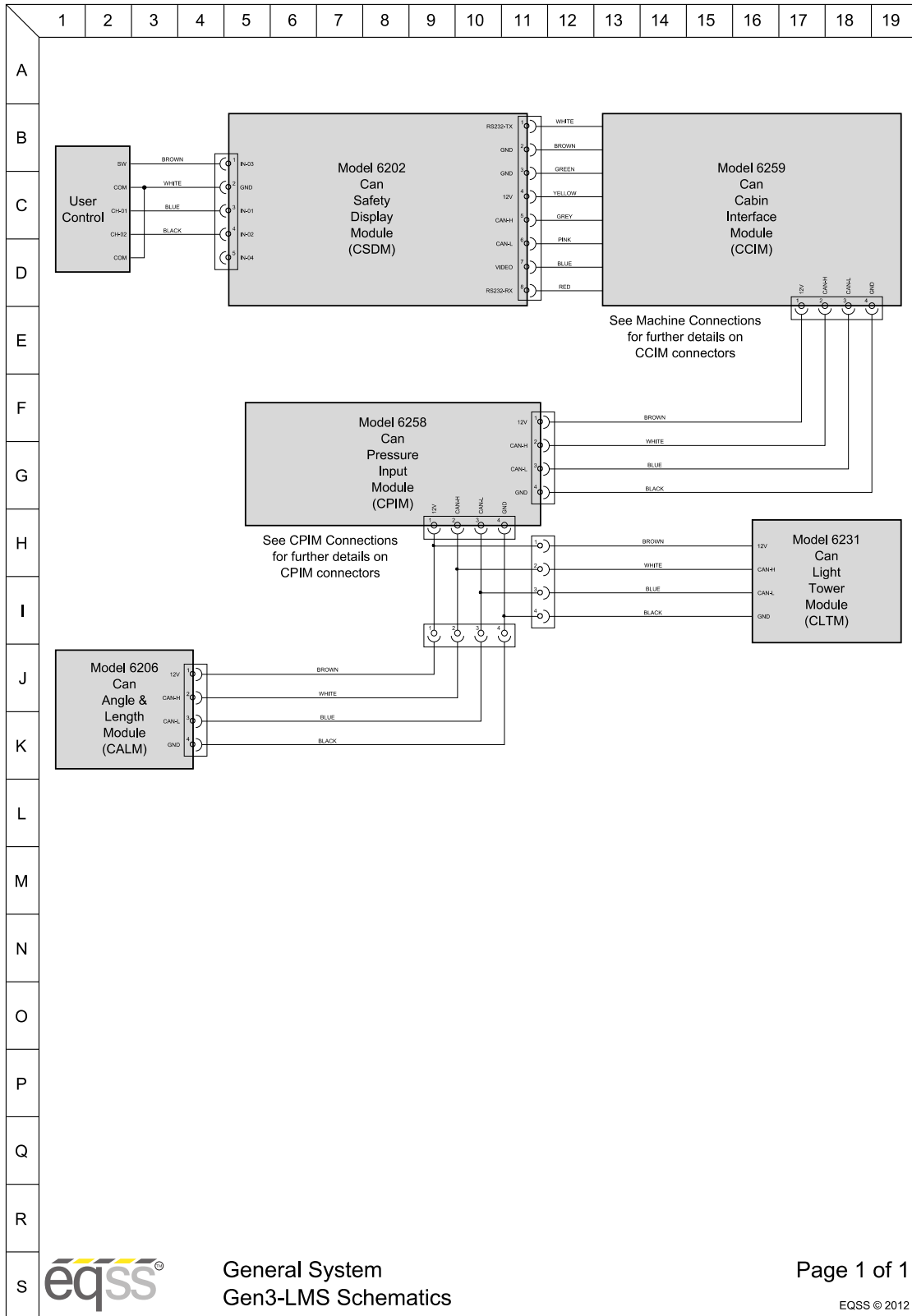

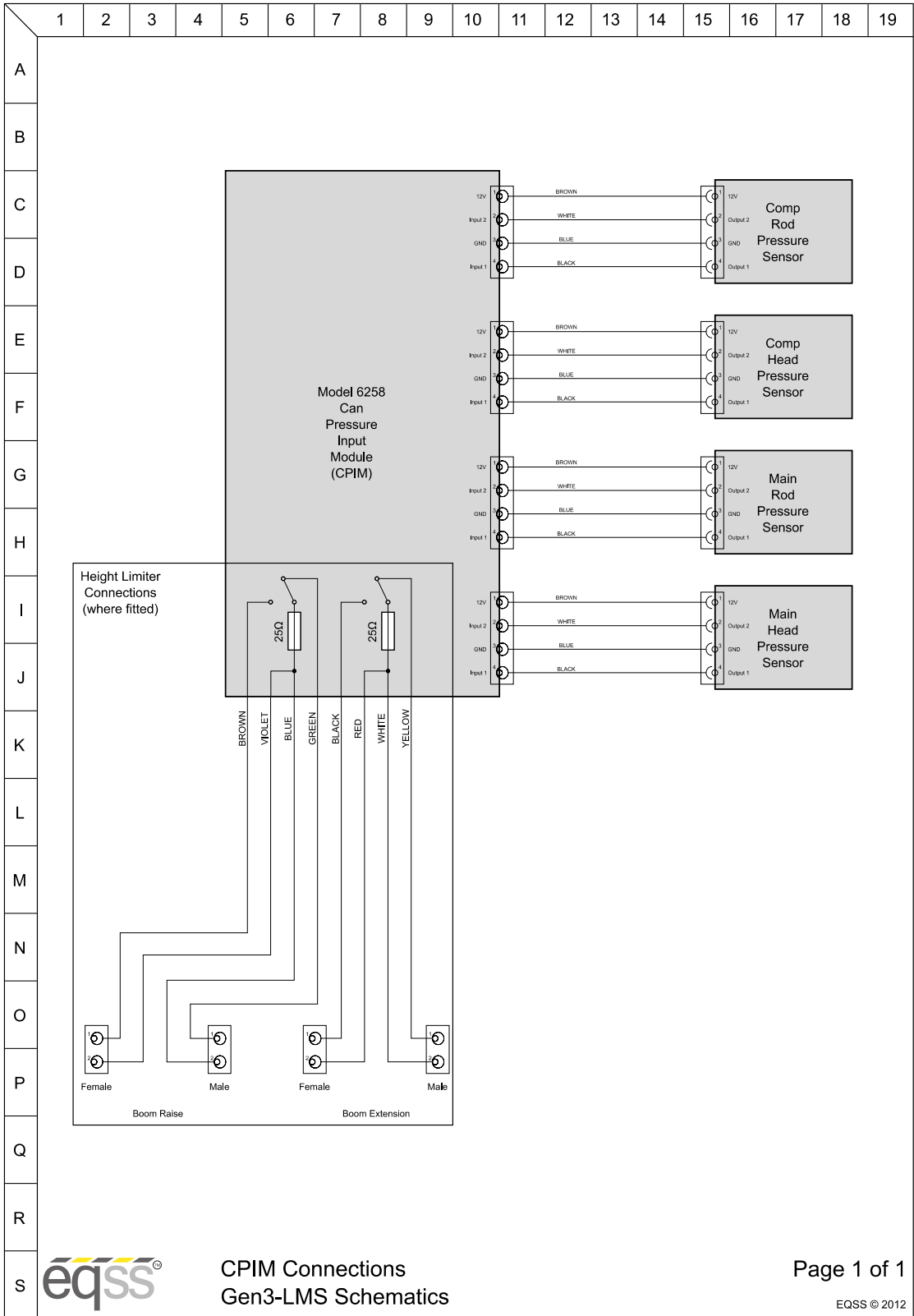

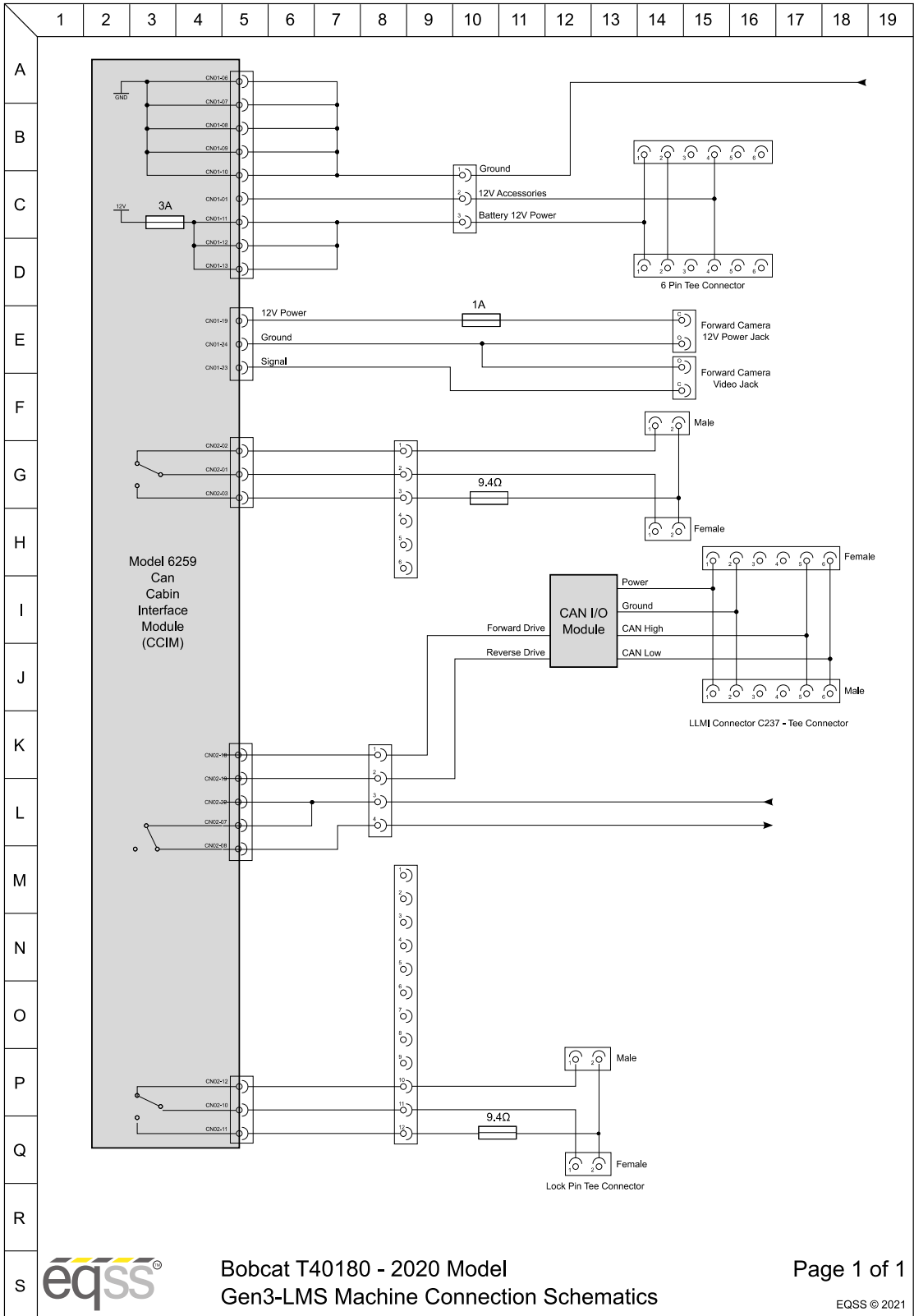



# Appendix A: Attaching Display Connectors

The procedure below describes the correct method of attaching the cables to the screw lock connectors on the display.



If the M12 screw lock connectors on the display are over tightened, it will twist the connector pins attaching the connector to the PCB.

<i>Step</i>	<i>Description</i>	<i>Diagram</i>
1.	<p>Connect the cable from the user control to the top 5 pin connector on the display.</p> <p>Connect the cable from the CCIM to the bottom 8 pin connector on the display.</p>	
2.	<p>Line up the alignment hole on the cable connector with the alignment notch on the display connector.</p>	



<i>Step</i>	<i>Description</i>	<i>Diagram</i>
3.	Push the female connector from the cable into the male connector on the display.	
4.	Rotate the nut on the female connector by hand in a clockwise direction, until the tension on the nut starts to increase.	
5.	Push the cable in again and repeat steps 3 and 4 until the connector is secure.	

Table 18: Install Display Connector Procedure



The method to correctly secure the cable is to push-twist-push-twist until the connector is fully inserted and secure. This will minimise the twisting force applied to the connector.

Below is a picture of a damaged connector on the PCB inside the display. This damaged occurred because the connector was over tightened.

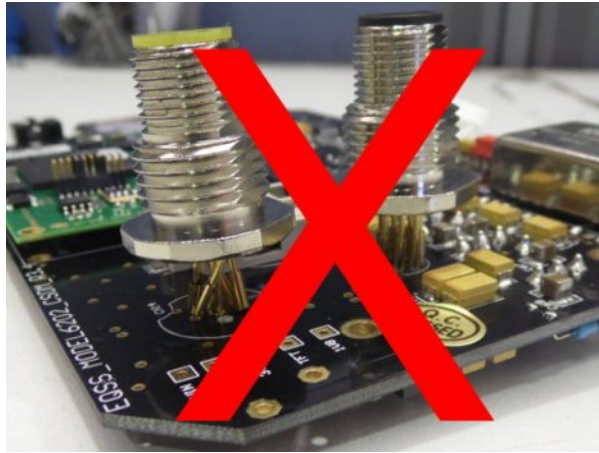

*Illustration 4: Damaged Display Connector*



Do not use any tools to tighten the connector.



*Illustration 5: Do Not Use Tools To Tighten Connector*



Do not over-tighten the nuts on the back of the display connectors. These nuts should only be hand tightened. If the nuts are overtightened it will damage the PCB inside the display.



*Illustration 6: Do Not Over Tighten Nuts*



Damage to the display connectors is not covered under warranty.

# Appendix B: Reattach Ferrites

If the clip-on ferrites on the displays are removed during installation, they will need to be reattached as shown in the procedure below.

 If the ferrites are not reinstalled or attached in the specified location the Gen3-LMS kit will not meet the AS/NZS CISPR 22:2006 certification.

<i>Step</i>	<i>Description</i>	<i>Diagram</i>
1.	<p>Attach the two clip-on ferrites at a location of 60 mm and 260 mm from the start of the connector to the start of the ferrite.</p> <p>Do this for both the CCIM and user control cables that plug into the display.</p>	

Table 19: Reattach Ferrites Procedure

# Indexes and Tables

## Illustration Index

Illustration 1: Machine Boom.....	8
Illustration 2: Machine Chassis.....	9
Illustration 3: Cable Reeler Mounting Position.....	15
Illustration 4: Damaged Display Connector.....	50
Illustration 5: Do Not Use Tools To Tighten Connector.....	50
Illustration 6: Do Not Over Tighten Nuts.....	51

## Index of Tables

Table 1: Component Installation Index.....	6
Table 2: Cable Installation Index.....	7
Table 3: Cover removal.....	12
Table 4: Cable Reeler Installation.....	14
Table 5: Pressure Sensor Installation.....	17
Table 6: Compensation Pressure Sensor Installation.....	19
Table 7: Can Pressure Input Module (CPIM) Installation.....	21
Table 8: Signal Light Installation.....	24
Table 9: Forward Camera Installation.....	25
Table 10: External Cable Completion.....	30
Table 11: Display Installation.....	31
Table 12: User Control Installation.....	32
Table 13: CCIM Installation.....	33
Table 14: Machine Connections.....	36
Table 15: Cabin Loom Installation.....	38
Table 16: Finalisation.....	41
Table 17: Sensor Calibration.....	44
Table 18: Install Display Connector Procedure.....	49
Table 19: Reattach Ferrites Procedure.....	52

---

**Equipment Safety Systems Pty. Ltd.** ABN: 31 061 789 151  
75 Naxos Way, Keysborough 3173, Victoria, Australia

Tel: +61 3 8770 6555  
Fax: +61 3 8770 6590  
Web: [www.eqss.com.au](http://www.eqss.com.au)