



eqssTM Gen-3 LMS Telehandler Load Management System

Installation Manual for Privilege MT1440 Standard Automatic Tool Recognition

Failure To Follow Installation Manual Will Void Warranty

Documentation Conventions

The list below highlights important documentation conventions.



Text presented in this manner is intended to provide the user with some general information. The user should ensure information presented in this manner is clearly understood.



Text presented in this manner provides the user with information to assist in completion of the current procedure being explained.



Text presented in this manner indicates that a failure to follow directions could result in damage to equipment, loss of information, bodily harm, or loss of life.

Important Information

Information contained in this publication regarding this device's applications and the like is provided only for your convenience and may be superseded by updates. It is your responsibility to ensure that the application or our equipment meets with your specifications.

EQUIPMENT SAFETY SYSTEMS MAKE NO REPRESENTATIONS OR WARRANTIES OF ANY KIND WHETHER EXPRESS OR IMPLIED, WRITTEN OR ORAL, STATUTORY OR OTHERWISE, RELATED TO THE INFORMATION, INCLUDING BUT NOT LIMITED TO ITS CONDITION, QUALITY, PERFORMANCE, MERCHANTABILITY OR FITNESS FOR PURPOSE.

Equipment Safety Systems disclaims all liability arising from this information and its use. Use of Equipment Safety Systems' products as critical components in life support systems is not authorised except with express written approval by Equipment Safety Systems. No licenses are conveyed, implicitly or otherwise, under any Equipment Safety Systems intellectual property rights.

Table of Contents

Tools Required for Installation.....	6
Installation Index.....	7
Covers.....	12
Cable Reeler Installation.....	14
Cable Reeler Mounting Position.....	18
ID Reader Installation.....	19
ID Reader Mounting Position.....	22
Pressure Sensor Installation.....	23
Pressure Manifold.....	23
Compensation Pressure Sensors.....	25
Reverse Camera.....	26
Cutout Cable Harness.....	28
Forward Camera.....	31
Stabiliser Cable Harness.....	33
Light Tower Installation.....	34
Light Tower Bracket Mounting Position.....	35
Machine Input Harness.....	36
Can Pressure Input Module (CPIM).....	37
External Cable Completion.....	38
Display Installation.....	40
User Input Control.....	41
Can Cabin Interface Module (CCIM).....	42
Cabin Loom.....	43
Finalisation.....	46

Sensor Calibration..... 49

Schematics..... 51

Indexes and Tables..... 54

Tools Required for Installation

The tools required to perform the installation of the TSS are listed below

- Pencil or Texta
- Drill
- Drill bits
 - 3.3 mm
 - 4.5 mm
 - 5 mm
 - 6.25 mm
 - 6.8 mm
 - 8.5 mm
- Centre punch
- Tap T-Handle
- Taps
 - M6
 - M7 x 0.75
 - M8
- Drill and tap oil
- Metric Allen keys
- Phillips Head screw driver
- Spanners and sockets
 - 7 mm
 - 10 mm
 - 13 mm
- Loctite thread locker
- Side cutters
- Stanley knife
- Crimpers
- Wire strippers

Installation Index

The components and cables of the Gen-3 Telehandler Load Management System are outline in the tables below. The following pages show where the components are installed and the cable routing.

See the appropriate manual section for a detailed installation description for each component.



Refer to this section for any component placement or cable routing issues

<i>Item</i>	<i>Component Description</i>
1	Cable Reeler
2	Main Lift Cylinder Pressure Sensors
3	Compensation Cylinder Pressure Sensors
4	Can Pressure Input Module (CPIM)
5	Forward Camera
6	Light Tower
7	Rear Camera
8	Can Cabin Interface Module (CCIM)
9	Display Module
10	User Control Dial
11	Stabiliser Connections
12	Joystick (X67)
13	Cutout

Table 1: Component Installation Index

<i>Colour</i>	<i>Cable Description</i>
Yellow	Boom Cable
Dark Green	Main Cylinder Pressure Sensor Cables
Dark Blue	Compensation Cylinder Pressure Sensors Cables
Light Blue	Forward Camera Cable
Violet	Light Tower Cable
Aqua	Rear Camera Cable
Dark Purple	CCIM Cable
Yellow/Green	Cutout Cable Harness
Brown	Joystick Cable Harness
Dark Yellow	Stabiliser Harness
Red	Display Cable
Orange	User Input Control Cable

Table 2: Cable Installation Index

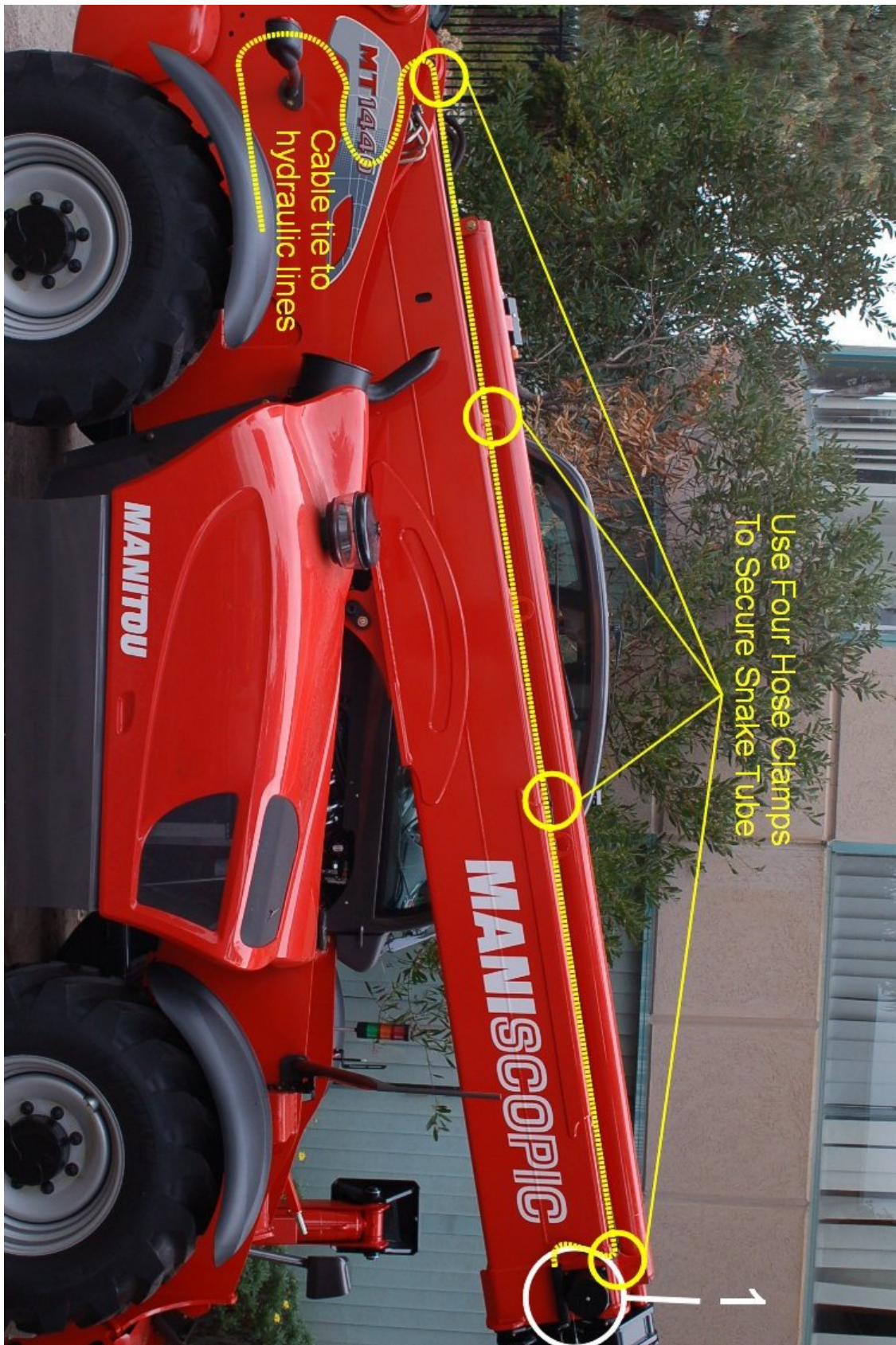

Illustration 1: Machine Boom

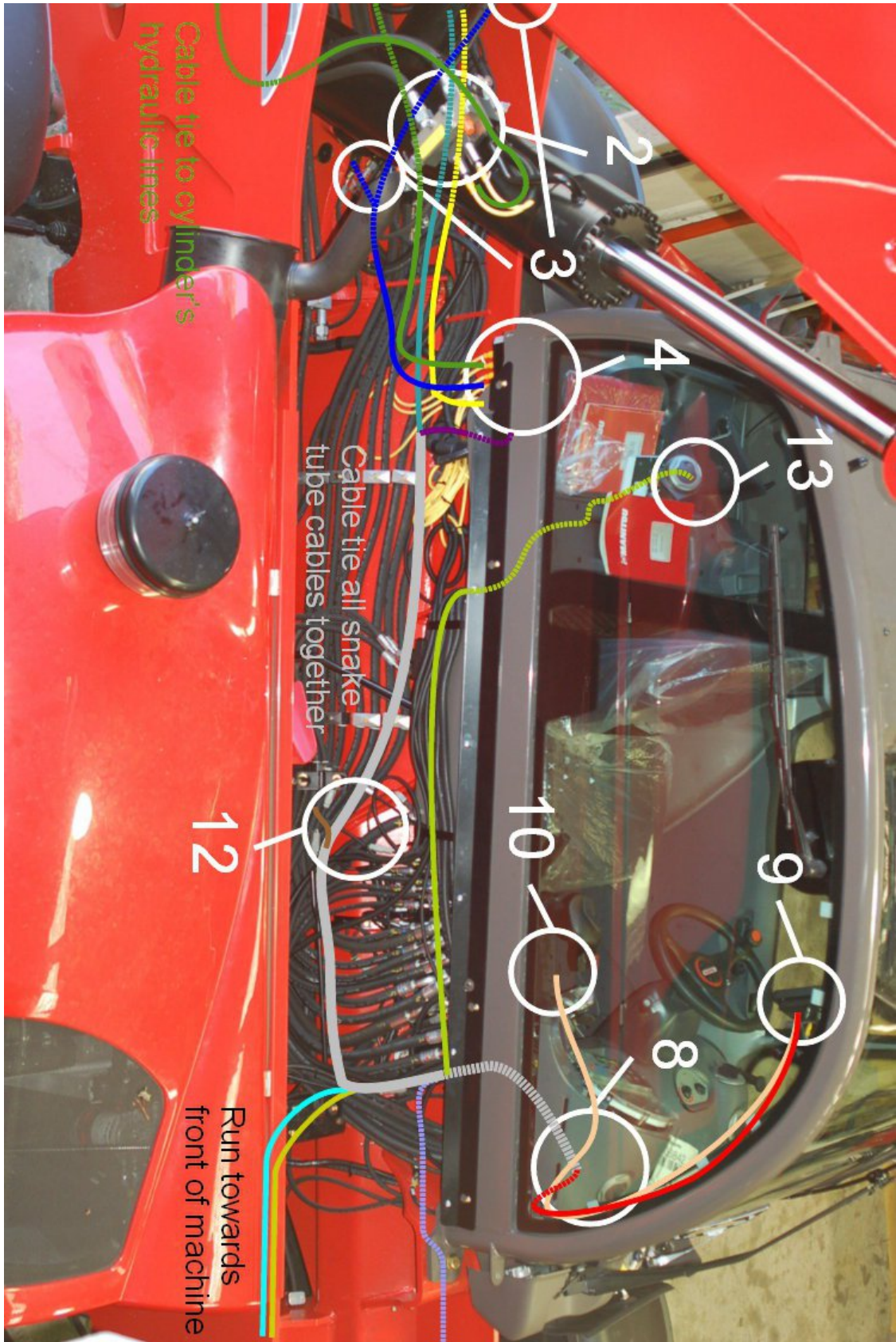

Illustration 2: Machine Chassis

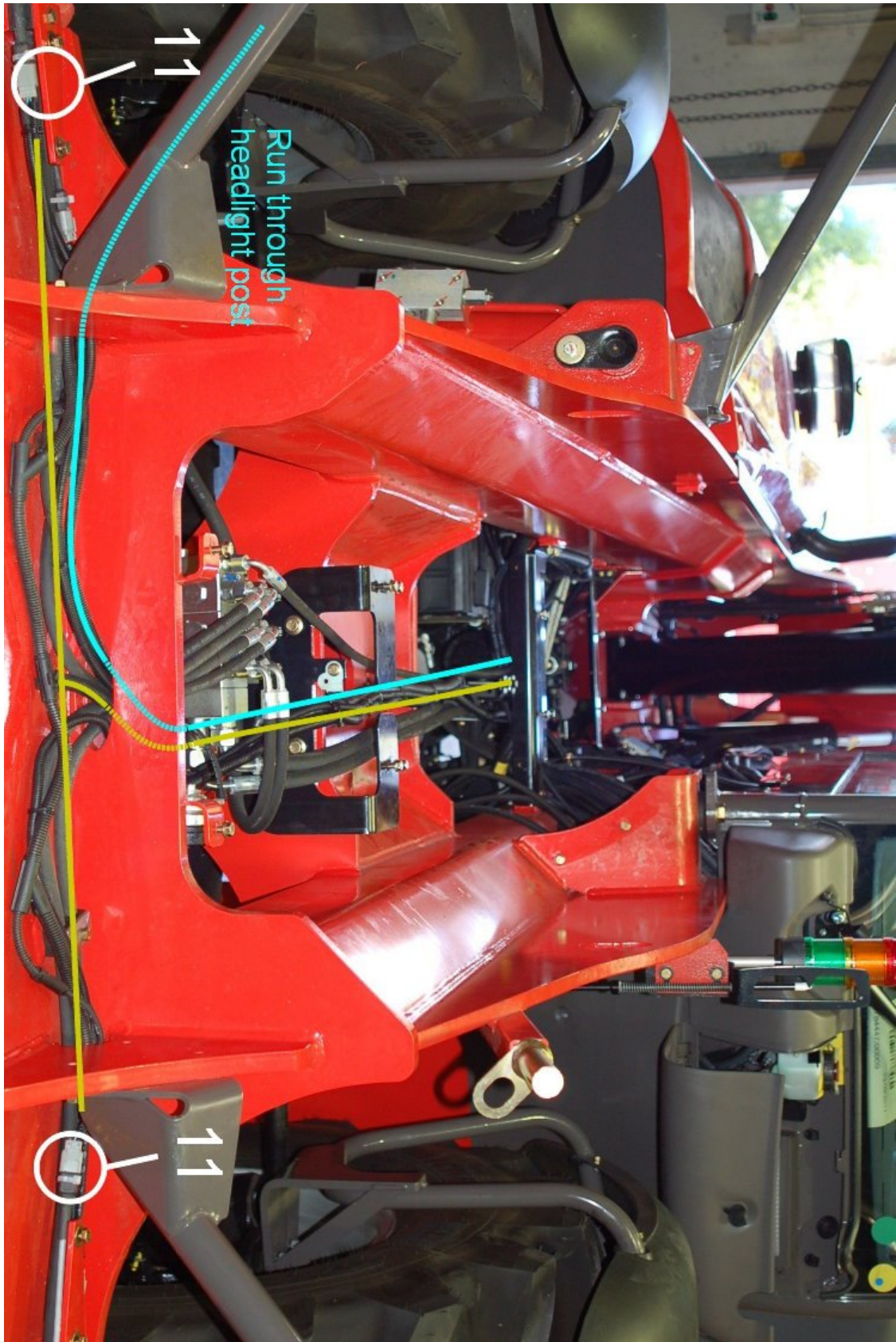

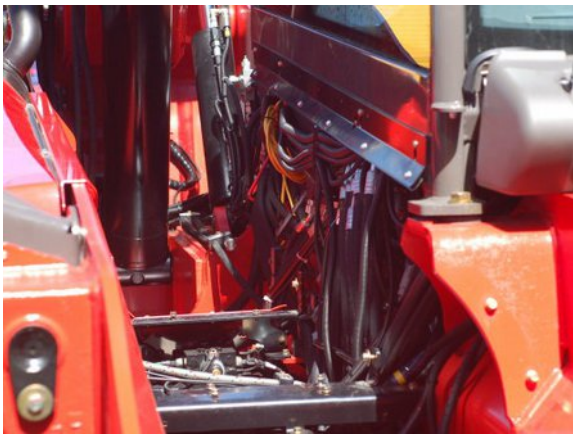



Illustration 3: Front of Machine

Covers

Remove the following covers before starting the installation

<i>Step</i>	<i>Description</i>	<i>Diagram</i>
1.	Remove the top rear cover behind the boom.	
2.	Remove the side panel next to the cabin under the boom.	
3.	Remove the covers under the boom. Remove the covers over the stabiliser connections	





<i>Step</i>	<i>Description</i>	<i>Diagram</i>
4.	Remove the cover behind the cabin	
5.	Inside the cabin remove the dashboard display.	

Table 3: Cover removal

Cable Reeler Installation

The cable reeler is used to measure the boom extension to determine the maximum lifting capacity.

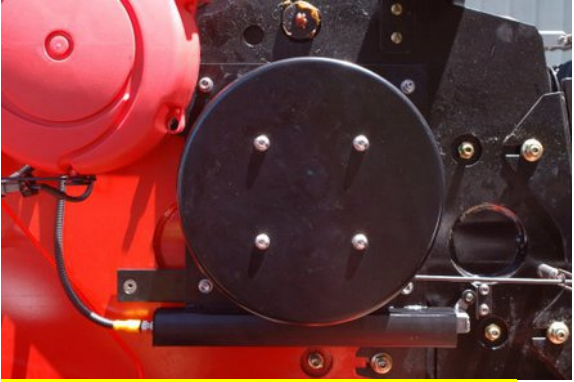
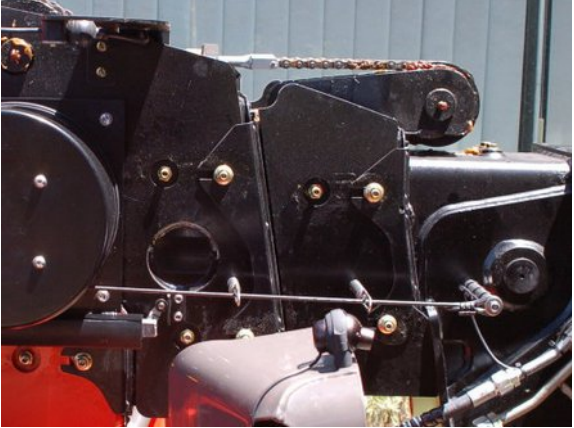
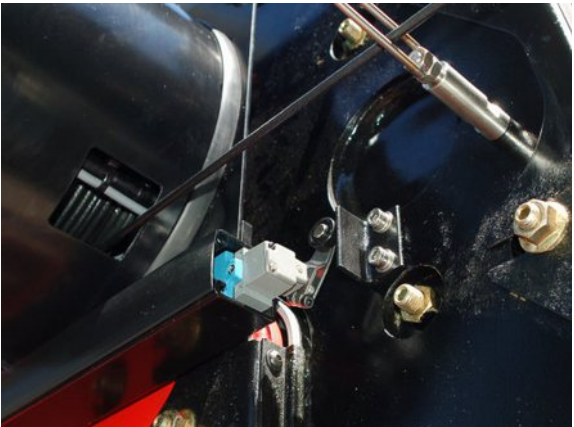
<i>Step</i>	<i>Description</i>	<i>Diagram</i>
1.	<p>Drill and tap the holes for the cable reeler according to the mounting diagram on page 18.</p> <p>Mount using the supplied M6 x 16 mm bolts and washers.</p>	 <p data-bbox="863 869 1382 902">new picture required for MT1440</p>
2.	<p>Drill and tap an M8 hole for the cable anchor. Ensure the cable anchor is positioned so the cable runs in line with the boom.</p> <p>Drill and tap an M8 hole for the cable guides.</p> <p>Mount the cable anchor and guides.</p> <p>Run the cable through the guides and secure to the cable anchor.</p>	
3.	<p>Drill and tap the M6 holes for the stow switch trigger. Ensure the stow switch is pressed when the boom is retracted.</p> <p>Mount the stow switch trigger using the supplied M6 x 12 mm bolts and washers.</p>	

<i>Step</i>	<i>Description</i>	<i>Diagram</i>
4.	Connect the supplied M12 10 metre cable (CB001027) into the cable reeler connection.	 A close-up photograph of a red cable reeler. A black, flexible, braided cable is connected to a port on the side of the reeler. The reeler has a white logo on its side. The background is slightly blurred, showing other parts of the equipment.

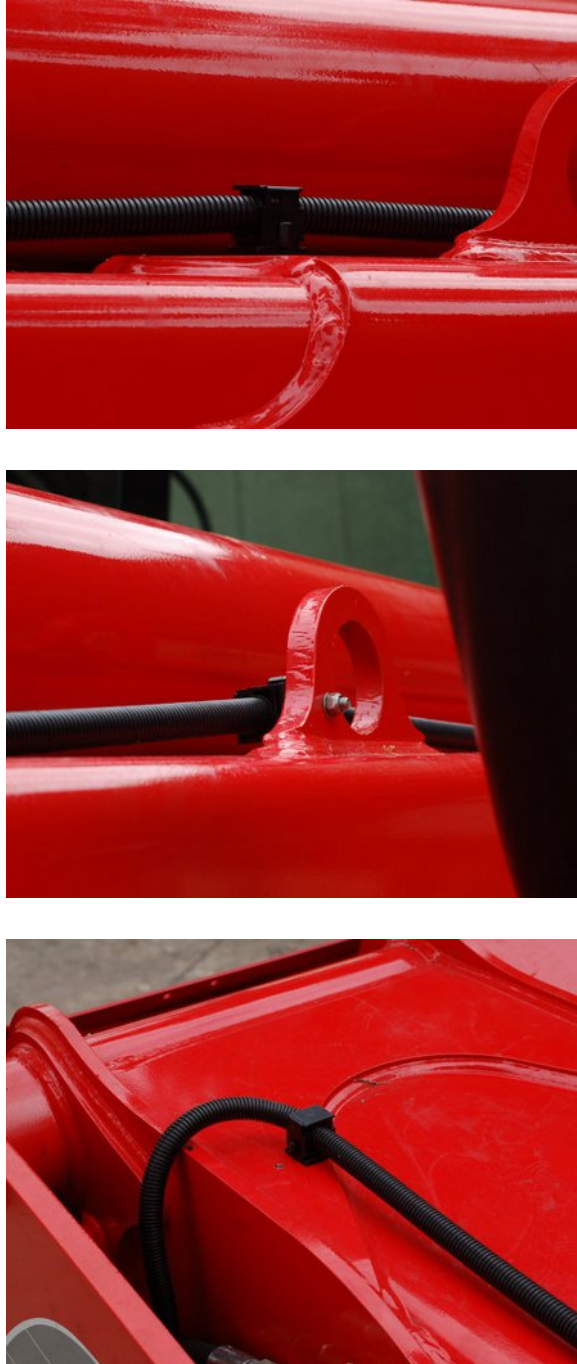
<i>Step</i>	<i>Description</i>	<i>Diagram</i>
5.	<p>Drill or tap four M6 holes spaced along the boom into the reinforcement and the boom lift points. Do not drill directly into the boom structure. Refer to the index on page 9 for hole placements.</p> <p>Install a plastic hose clamp at each hole location</p>	

<i>Step</i>	<i>Description</i>	<i>Diagram</i>
6.	<p>Run the cable along the top of the boom, secure to each of the hose clamps.</p> <p>Cable tie to the flexible hydraulic hoses down to the chassis. Make sure the cable isn't pinched or stretched when the boom is raised or lowered.</p> <p>Run the remainder of the cable towards the cabin and insert into snake tube with the reverse camera cable during External Cable Completion on page 38.</p>	

Table 4: Cable Reeler Installation



For further details on running the boom cable refer to the Installation Index on page 7

Cable Reeler Mounting Position

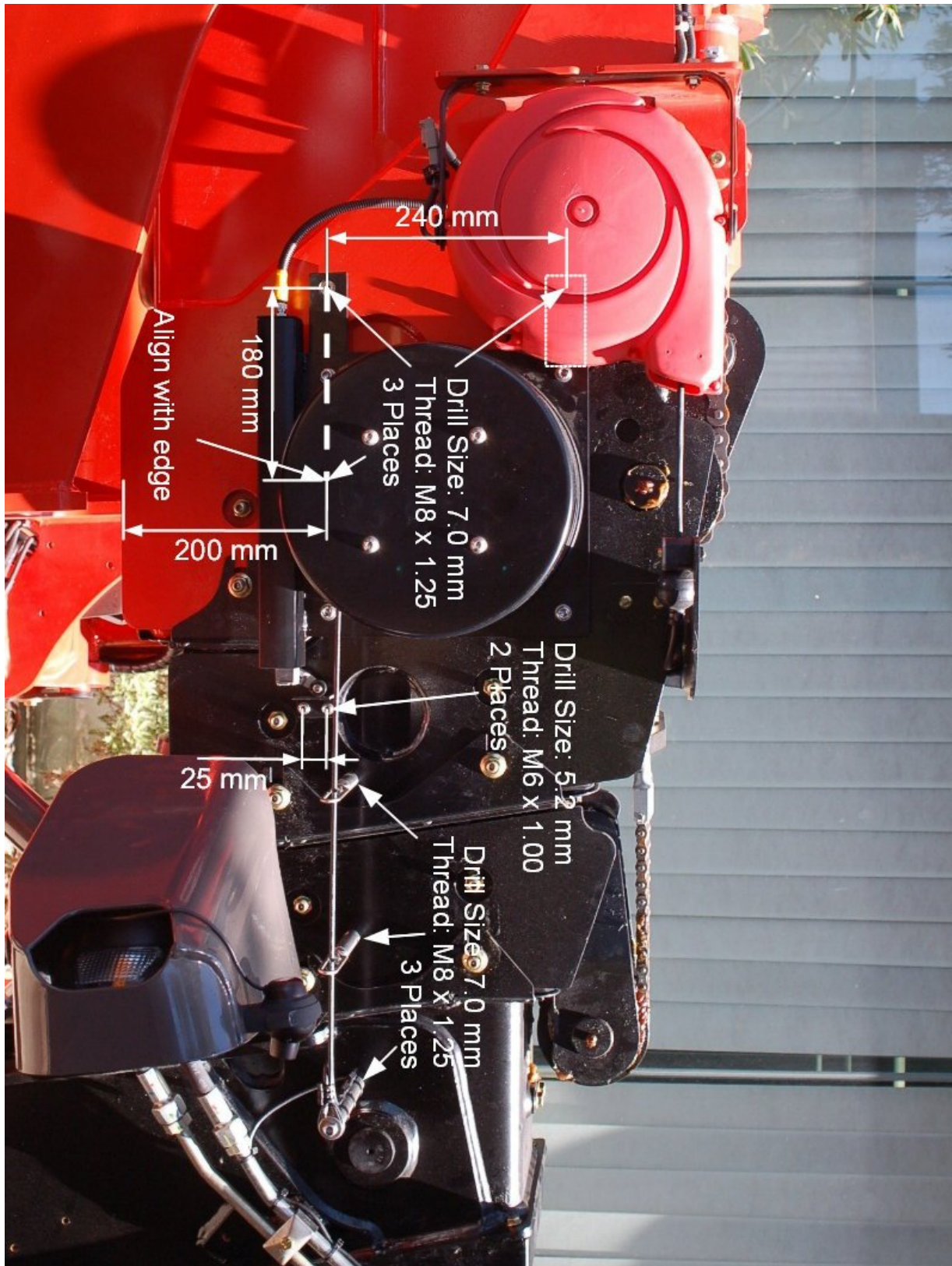

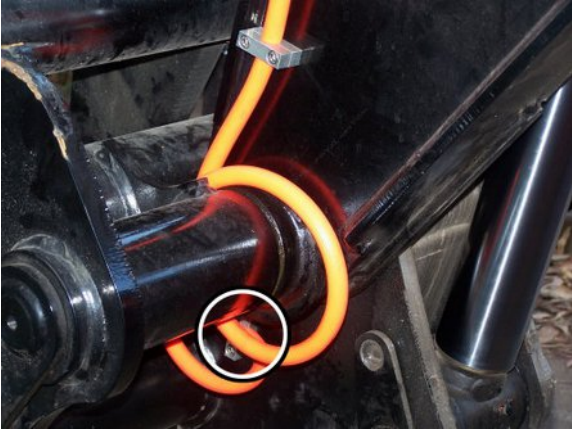



Illustration 4: Cable Reeler Mounting Position **New Picture required for MT1440**

ID Reader Installation

The ID reader is mounted on the front of the attachment head and is used to determine the attachment in use.

<i>Step</i>	<i>Description</i>	<i>Diagram</i>
1.	<p>Drill the holes for the ID reader according to the mounting description on page 22.</p> <p>Remove the M4 bolts attaching the ID reader to the mounting bracket, to allow access to the bracket mounting holes.</p> <p>Secure the mounting plate to the attachment head using three M6 x 12 mm bolts and washers.</p> <p>Re-attach the ID reader to the mounting bracket.</p>	 A photograph showing the ID reader mounted on the front of the attachment head. The reader is a small, rectangular device with a lens, secured to a black metal bracket. An orange cable is connected to the side of the reader. The background shows the dark, heavy-duty metal structure of the attachment head.
2.	<p>Drill and tap two M6 holes to attach the supplied metal hose clamp to the attachment head.</p> <p>Ensure the clamp is pointing in the direction shown.</p> <p>Secure the cable hose to the hose clamp.</p> <p>Note: The hose shown here is orange.</p>	 A close-up photograph of the orange cable hose being secured to a metal hose clamp. The clamp is a silver-colored metal ring with a bolt. The orange hose is looped through the clamp and is being tightened onto a black metal component of the attachment head. A white circle highlights the point where the hose is secured to the clamp.

<i>Step</i>	<i>Description</i>	<i>Diagram</i>
3.	<p>Drill and tap two M6 holes to attach the supplied metal hose clamp to the attachment head.</p> <p>Ensure the clamp is pointing in the direction shown.</p> <p>Wrap the cable hose around the attachment head pivot.</p> <p>Secure the cable hose to the hose clamp. Ensure there is approximately 950 mm of cable between the two clamps.</p> <p>Rotate the attachment head through its range of motion and ensure the hose is not pinched or stretched.</p> <p>Drill and tap an M6 hole to attach the supplied plastic hose clamp.</p> <p>Secure the cable hose to the hose clamp.</p> <p>Cable tie the remainder of the hose to the hydraulic lines leading under the front cover.</p>	
4.	<p>Drill and tap an M6 hole to attach the supplied plastic hose clamp.</p> <p>Secure the cable hose to the hose clamp.</p> <p>Cable tie the remainder of the hose to the hydraulic lines leading under the front cover.</p>	



<i>Step</i>	<i>Description</i>	<i>Diagram</i>
5.	Cable tie the cable down the cable anchor and along the hydraulic lines leading under the front cover.	
6.	<p>Remove the front cover and attach the 3 pin connector from the cable reeler to the ID reader connector.</p> <p>Replace the cover.</p>	

Table 5: ID Reeler Installation

ID Reader Mounting Position

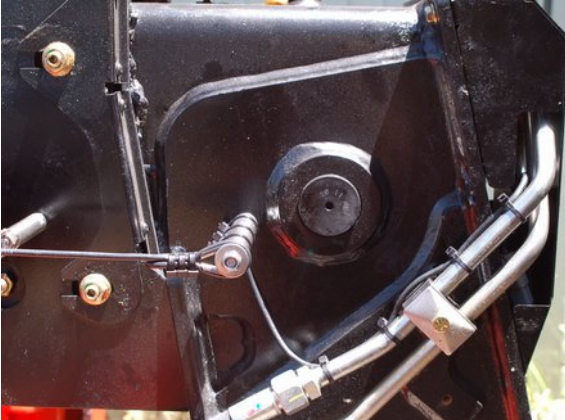
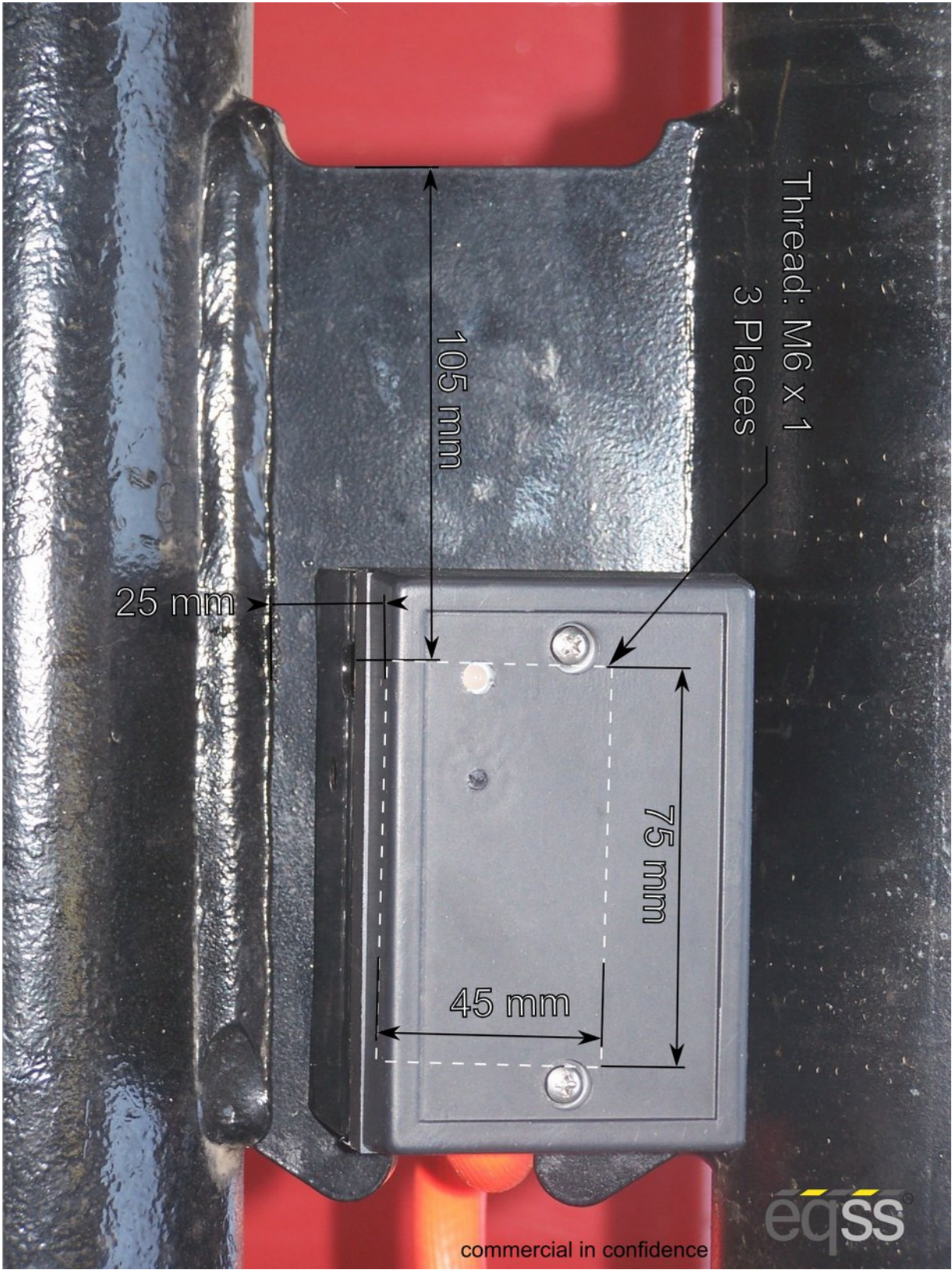

Illustration 5: ID Reader Mounting Position

Pressure Sensor Installation

The hydraulic pressure sensors are used to measure the lifting load of the telehandler.

Pressure Manifold

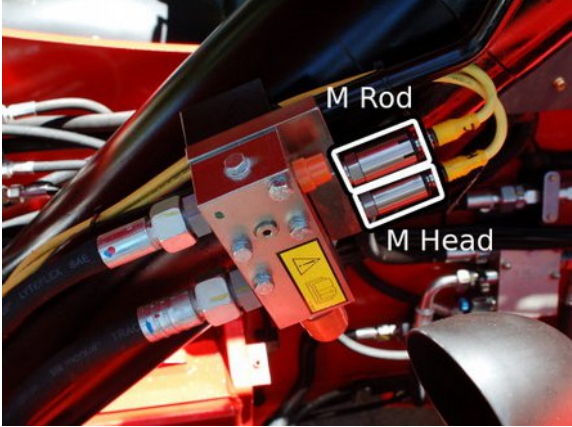

Failure to tighten the bolts to the correct torque on the pressure manifold may result in a pressure failure on the counterbalance valve causing an uncontrolled fall of the boom.

<i>Step</i>	<i>Description</i>	<i>Diagram</i>
1.	<p>Raise the boom to approximately 40 degrees.</p> <p>Support and secure the boom using an A Frame or similar apparatus. It must support at least 2 tons.</p> <p>Apply the handbrake and insert chock under wheels.</p> <p>Remove the counterbalance valve on the side of the hydraulic lifting ram.</p> <p>Removing the counterbalance valve will release the hydraulic pressure which may result in a spray of oil.</p> <p>Secure the pressure manifold using the supplied 70 mm bolts and seals. Tighten the bolts for the manifold to 25 NM using a torque wrench.</p> <p>Start the machine, pressurise the boom and check for leaks.</p>	



<i>Step</i>	<i>Description</i>	<i>Diagram</i>
2.	<p>Connect the supplied M12 4 metre cables (CB001026) into each of the pressure sensors.</p> <p>Add both cables to 3 m of snake tube. Cable tie to the flexible hydraulic hoses connected to the main lift cylinder. Make sure the cable isn't pinched or stretched when the boom is raised or lowered.</p> <p>Run the snake tube and cables towards the cabin and cable tie with the other cables during External Cable Completion on page 38.</p>	

Table 6: Pressure Manifold Installation



For further details on running the pressure sensor cables refer to the Installation Index on page 7

Compensation Pressure Sensors

<i>Step</i>	<i>Description</i>	<i>Diagram</i>
1.	Install the pressure sensor with the U shaped hydraulic connection into the rod of the compensation cylinder	 <p data-bbox="863 757 1425 831">View from behind the cabin towards the rear of the machine</p>
2.	<p data-bbox="272 853 735 969">Install the head compensation pressure sensor into the compensation cylinder</p> <p data-bbox="272 1019 778 1093">Start the machine, pressurise the boom and check for leaks.</p> <p data-bbox="272 1144 820 1261">Connect the supplied M12 4 metre cables (CB001026) into each of the pressure sensors.</p> <p data-bbox="272 1310 772 1384">Add both cables to 3 m of snake tube.</p> <p data-bbox="272 1435 831 1592">Run the snake tube and cables towards the cabin and cable tie with the other cables during External Cable Completion on page 38.</p>	 <p data-bbox="863 1279 1414 1352">View from under the boom towards the rear of the machine</p>

Table 7: Compensation Pressure Sensor Installation



For further details on running the pressure sensor cables refer to the Installation Index on page 7

Reverse Camera

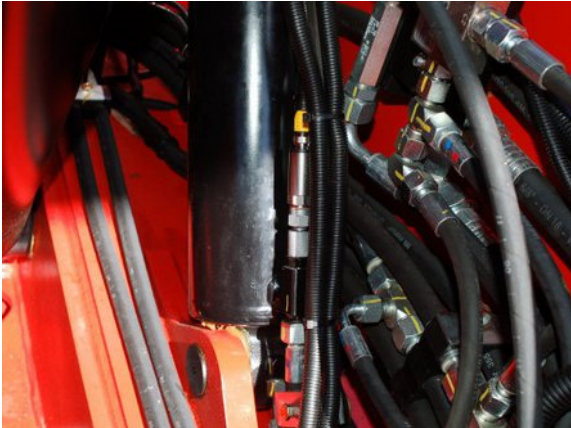
The rear camera video is displayed on the screen when the machine is in reverse gear to allow the operator to see behind the telehandler while reversing.



Do not disconnect the camera power connection while the system is operating as this can damage the fuse.



<i>Step</i>	<i>Description</i>	<i>Diagram</i>
1.	<p>Remove the cover at the rear of the machine.</p> <p>Drill a 31mm hole in the location shown. Making sure to leave enough room for a license plate</p> <p>Insert the camera through the hole and adjust the angle using the alignment washers.</p>	
2.	<p>Connect the camera power and signal connectors to the supplied 5m camera cable (CB001032).</p> <p>Note; The white connector is not used.</p> <p>Secure the camera cable using a single cable tie to maintain the connector location.</p> <p>Run the remainder of the cable towards the cabin and insert into snake tube with the boom cable during External Cable Completion on page 38.</p>	

Table 8: Reverse Camera Installation



The camera's viewing angle may need to be adjusted once the system is installed and the display is operational.



Once the cable has secured with a cable tie disconnect the cable to remove the rear cover until the installation is finalised



For further details on running the camera cable refer to the Installation Index on page 7

Cutout Cable Harness



Isolate the main battery before connecting into the machine wiring

<i>Step</i>	<i>Description</i>	<i>Diagram</i>
1.	Remove connector X148 from the ECU MP1.	
2.	<p>Pull the connector on the left of the connector to disconnect from the ECU.</p> <p>Slide the protective cover off the end of the connector to access the wires.</p>	
3.	Remove the pin support bracket from the left connector, by levering the corners with a small screwdriver.	





<i>Step</i>	<i>Description</i>	<i>Diagram</i>
4.	Remove the blanking pin from the connector in slot 4 and insert the blue wire from the cutout harness. Note: The pin numbers are written on the front of the connector	
5.	Replace the pin support bracket and the protective cover. Replace any tape that was removed to secure the snake tube of the protective cover. Reattach the connector to the ECU module.	
6.	Run the cable from behind the cabin to the side of the chassis following the existing snake tube.	
7.	Run the snake tube and cables towards the cabin and cable tie with the other cables during External Cable Completion on page 38.	

Table 9: Rear Cable Harness Installation



For further details on running the cutout cable harness refer to the Installation Index on page 7



The green wire on the wire harness is not needed to complete the installation for this machine configuration.

Forward Camera

The forward camera video is displayed on the screen when the machine is in forward gear to allow the operator to see past the boom to obstructions that would damage the right front tyre.



Do not disconnect the camera power connection while the system is operating as this can damage the fuse.



<i>Step</i>	<i>Description</i>	<i>Diagram</i>
1.	<p>Drill two 7 mm holes spaced 25 mm apart on the top of the right headlight to mount the camera.</p> <p>Mount the camera to the top of the headlight and secure using the supplied nuts.</p>	
2.	<p>Connect the camera power and signal connectors to the supplied 5m camera cable (CB001032).</p> <p>Note; The white connector is not used.</p> <p>Run the cable along the same path as the headlight cable through the headlight post.</p> <p>Run the remainder of the cable towards the cabin and cable tie with the stabiliser cable harness during External Cable Completion on page 38.</p>	

Table 10: Forward Camera Installation



The camera's viewing angle may need to be adjusted once the system is installed and the display is operational.



For further details on running the camera cable refer to the Installation Index on page 7

Stabiliser Cable Harness



Isolate the main battery before connecting into the machine wiring

Step	Description	Diagram
1.	<p>Locate the stabiliser down pressure switch connections at the front of the machine.</p> <p>Connect the 3 pin tee connector labelled left stabiliser into X97 and the connector labelled right stabiliser into X87 on the stabiliser cable harness.</p>	
2.	<p>Cable tie to the existing snake tube.</p> <p>Run the remainder of the cable towards the cabin and cable tie with the front camera cable harness during External Cable Completion on page 38.</p>	

Table 11: Stabiliser Cable Harness Installation



For further details on running the stabiliser cable harness refer to the Installation Index on page 7

Light Tower Installation

The light tower warns other workers when the telehandler is lifting loads close to its maximum capacity.

<i>Step</i>	<i>Description</i>	<i>Diagram</i>
1.	<p>Drill and tap the holes required to mount the light tower bracket on the chassis according to the mounting diagram on page 35.</p> <p>Secure using the supplied bolts as described on page 35.</p> <p>Run the cable through the gap between the chassis and the cabin towards the side of the cabin.</p> <p>Complete the cable installation during External Cable Completion on page 38.</p>	

Table 12: Light Tower Installation



For further details on running the light tower cable refer to the Installation Index on page 7

Light Tower Bracket Mounting Position

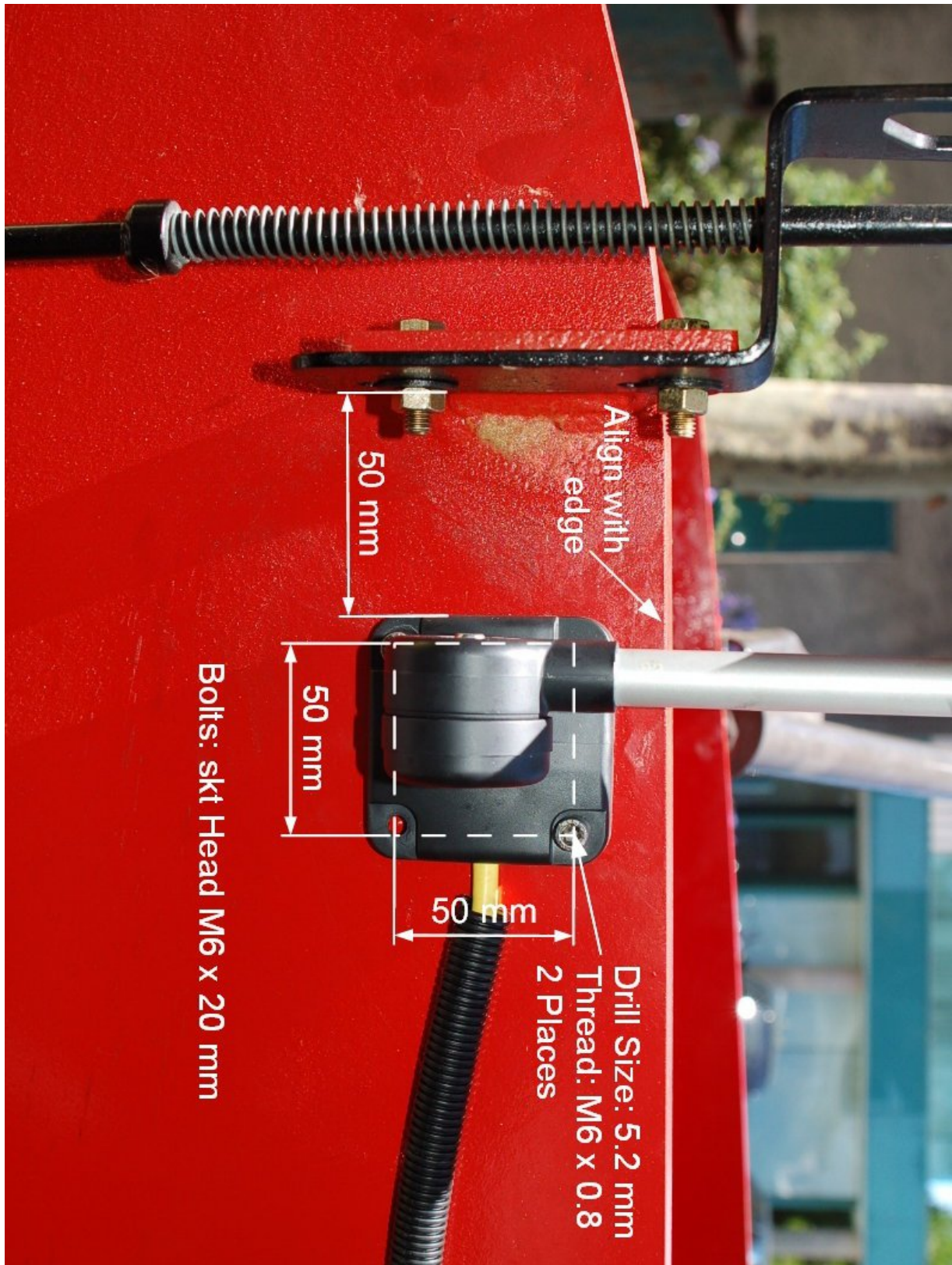

Illustration 6: Light Tower Bracket Mounting Position

Machine Input Harness



Isolate the main battery before connecting into the machine wiring

Step	Description	Diagram
1.	<p>Locate the 12 pin connector under the boom next to the cabin, that connect into the joystick.</p> <p>Connect the 12 pin tee connector from the machine input harness into X67.</p> <p>Run the other end of the cable with the 4 pin connector towards the cabin and cable tie with the other cables during External Cable Completion on page 38.</p> <p>Note: The violet and yellow wires near the 4 pin connector are not used.</p>	

Table 13: Joystick Cable Harness Installation



For further details on running the machine input harness refer to the Installation Index on page 7

Can Pressure Input Module (CPIM)

The CPIM is responsible for processing the information sent from the pressure sensors.



Accidentally swapping the pressure sensor connections will not damage system and can be determined if the display is showing a negative load.





Do not plug the pressure sensor cable into the far right side boom cable. This will damage the system.

<i>Step</i>	<i>Description</i>	<i>Diagram</i>
1.	<p>Drill and tap two M8 holes for the CPIM bracket in the chassis side panel.</p> <p>Ensure the cover behind the cabin can still be attached.</p> <p>Mount using the supplied M8 x 12mm bolts and washers.</p>	
2.	<p>Connect the cables for the pressure sensors and boom cable to the CPIM according to the picture shown.</p> <p>Note: The CCIM cable will be installed during External Cable Completion on page 38.</p>	

Table 14: Can Pressure Input Module (CPIM) Installation

External Cable Completion

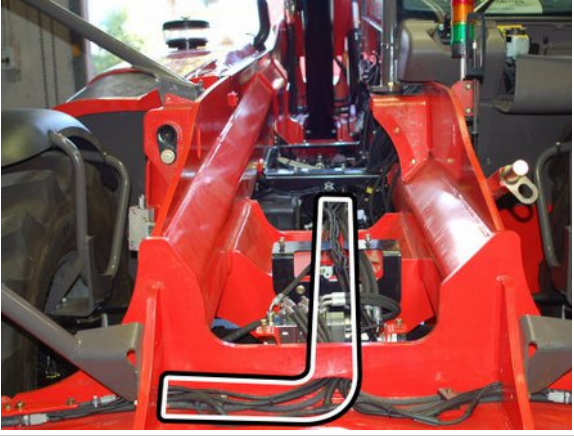
All external cabling is completed in this step.

<i>Step</i>	<i>Description</i>	<i>Diagram</i>
1.	Locate the reverse camera cable and run both cables up to the CPIM.	 <p data-bbox="863 882 1410 958">View from under the boom towards the rear of the machine</p>
2.	At the front of the machine cable tie the stabiliser and front camera cables together up to the CPIM.	
3.	<p data-bbox="272 1420 842 1621">Cable tie the pressure sensor, boom, cutout/platform cable harness, reverse camera and machine input cable harness together up to the CPIM.</p> <p data-bbox="272 1666 836 1787">Coil up the additional cabling for the pressure sensor and boom cables and store underneath the CPIM.</p>	



<i>Step</i>	<i>Description</i>	<i>Diagram</i>
4.	Connect the supplied M12 4 metre cable (CB001026) into the free connection out of the right side of the CPIM for the CCIM cable.	
5.	<p>Run the CCIM, light tower, cutout cable harness, stabiliser cable harness, machine input harness and camera cables up through the hole into the cabin under the dashboard.</p> <p>Note: Pull the entire length of cable through into the cabin, excess cable will be stored under the dashboard cover in the cabin.</p>	

Table 15: External Cable Completion

Display Installation

The display shows the current safety status of the telehandler.

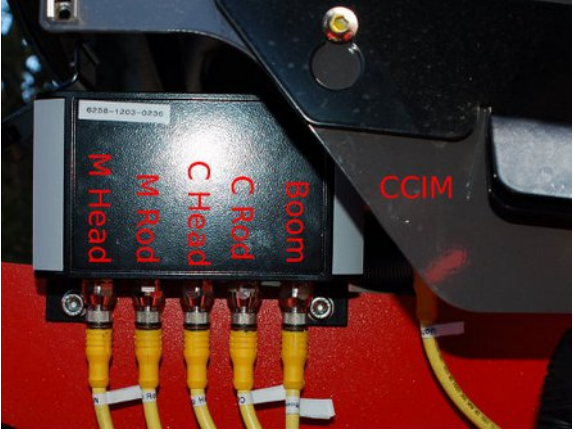
<i>Step</i>	<i>Description</i>	<i>Diagram</i>
1.	Attach the display bracket to the level indicator in the top right corner using the supplied M6 x 35 mm bolts and nuts. Attach the display to the bracket and tighten the grub screw	

Table 16: Display Installation



Adjust the display bracket for optimal viewing angle once the display is powered

User Input Control

The user input control consists of a 5 button switch mounted in the dashboard.



<i>Step</i>	<i>Description</i>	<i>Diagram</i>
1.	<p>Drill a 34 mm hole into the cover in front of the joystick and install the user control dial.</p> <p>Note: Be careful while drilling not to damage the hydraulic controls positioned under the cover.</p>	
2.	<p>Run the cable through under the dashboard with the other cables.</p>	

Table 17: User Input Control Installation

Can Cabin Interface Module (CCIM)

The CCIM connects the system into the machine electronics.



<i>Step</i>	<i>Description</i>	<i>Diagram</i>
1.	<p>Position the backup battery (to the right of the CCIM) underneath the dashboard using double sided velcro tape.</p> <p>Position the CCIM to the left of the backup battery using double sided velcro tape.</p> <p>Remove the battery and CCIM from the velcro to allow the connections to be completed. Reattach to the velcro in the section Finalisation on page 46.</p>	



Table 18: CCIM Installation

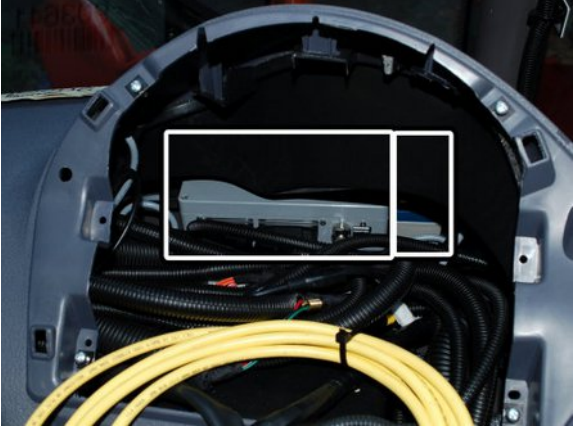

Cabin Loom

The cabin loom connects the CCIM to the machine connections and the other modules of the system.

 Isolate the main battery before connecting into the machine wiring

 Do not disconnect the camera power connection while the system is operating as this can damage the fuse.

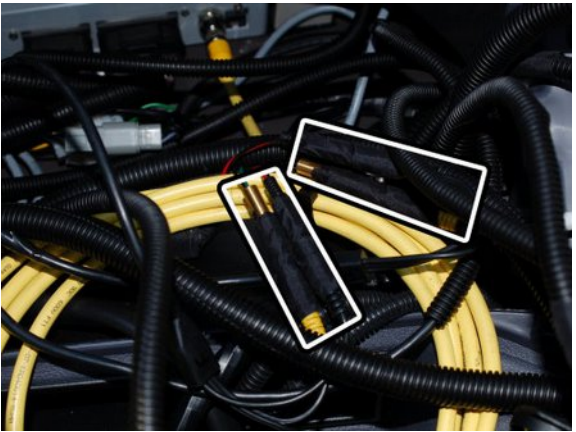
Step	Description	Diagram
1.	<p>Connect the CCIM and light tower cables to the M12 connectors on the CCIM.</p> <p>Note: It doesn't matter which of the M12 connectors the CCIM and light tower cables are plugged into.</p>	
2.	<p>Connect the Power/Camera and IO Harnesses to the bulkhead connectors on the CCIM.</p>	

<i>Step</i>	<i>Description</i>	<i>Diagram</i>
3.	Attach the ring lug from the cutout harness to the ground point underneath the dashboard.	
4.	Connect the camera power and signal cables to the cabin loom. Note: The white connector is not used.	
5.	Run the 8 pin cable from the CCIM through the gap between the window and the dashboard. Connect into the 8 pin connector into the display	
6.	Run the 5 pin user control cable along the top of the side window Leave the remaining cable under the roof cover. Connect into the 5 pin connector into the display	







<i>Step</i>	<i>Description</i>	<i>Diagram</i>
7.	<p>Run the cable through snake tube.</p> <p>Place cable tie points on the side of the window.</p> <p>Cable tie the snake tube to the cable tie points.</p>	

Table 19: Cabin Loom Installation

Finalisation

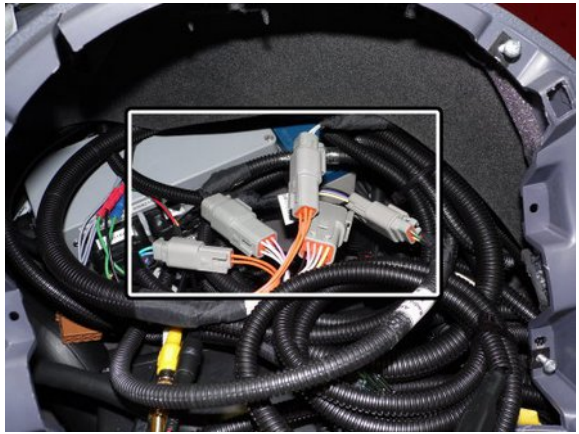
This section will complete the final power connections to power the system and finish any additional items.

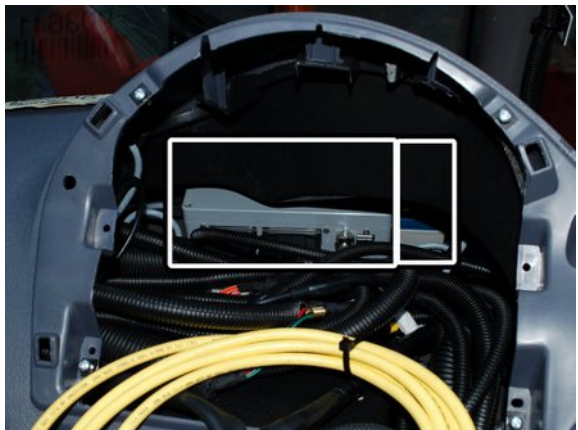
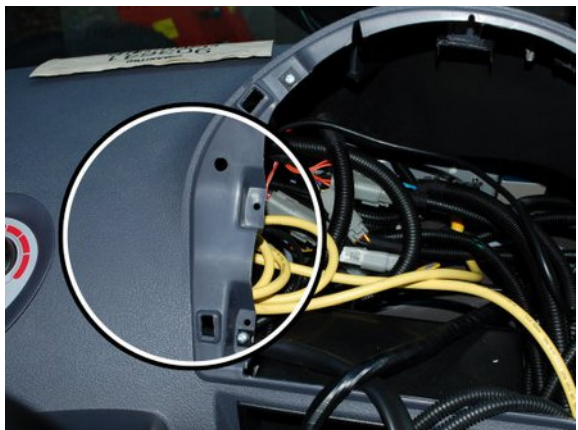
<i>Step</i>	<i>Description</i>	<i>Diagram</i>
1.	<p>Connect the radio power harness into the radio power connector.</p> <p>Ensure there is a 2A fuse installed in F10 and a 7.5A fuse installed in F26 for radio power.</p>	
2.	<p>Connect the 12 pin, 6 pin, 4 pin, 3 pin and 2 pin connectors into the cabin loom.</p>	
3.	<p>Connect the spade lug on the black wire to the negative (black) battery terminal.</p> <p>Connect the spade lug on the blue wire to the positive (red) battery terminal.</p>	

<i>Step</i>	<i>Description</i>	<i>Diagram</i>
4.	Attach the backup battery and CCIM to the velcro strips installed earlier.	
5.	Coil up the extra cables and store underneath the dashboard cover.	
6.	<p>Reconnect the main battery from the isolation switch.</p> <p>Turn the machine onto first stage /accessories and ensure the system is activated.</p> <p>Note: If the system is activated as soon as the battery power is reconnected, swap pins 2 and 3 on the 3 pin connector on the radio power harness.</p>	



<i>Step</i>	<i>Description</i>	<i>Diagram</i>
7.	<p>Adjust the display bracket for optimal viewing</p> <p>Set the machine into forward gear to activate the forward camera. Adjust the forward camera so the front right wheel is visible.</p> <p>Set the machine into reverse gear to activate the reverse camera. Adjust the reverse camera so the video is level.</p>	
8.	<p>Perform a final check on all the cabling and sensors.</p> <p>Replace all the covers</p>	

Table 20: Finalisation



Make sure to update the machine ECU software for Australian configuration using the Manitou pad.



Complete the system checklist once installation has been completed.

Sensor Calibration

Once the installation is complete, the sensors will require calibration.



A sensor calibration must be performed once the cable reeler and CPIM have been mounted. If the cable reeler or CPIM have been moved/repositioned a recalibration must be performed

<i>Step</i>	<i>Description</i>	<i>Diagram</i>
1.	<p>Press the user control dial to enter the menu system.</p> <p>Rotate the user control dial to select System Menu.</p> <p>Press the user control dial to enter the menu.</p>	<p>Main Menu</p> <hr/> <p>Attachment Selection Menu</p> <hr/> <p>System Menu</p> <hr/> <p>Exit Menu</p> <hr/>
2.	Select Advanced Menu	<p>System Menu</p> <hr/> <p>Volume / Brightness</p> <hr/> <p>Status Menu</p> <hr/> <p>Diagnostics Menu</p> <hr/> <p>System Tests</p> <hr/> <p>Advanced Menu</p> <hr/> <p>Return to Main Menu</p> <hr/>

<i>Step</i>	<i>Description</i>	<i>Diagram</i>										
3.	Enter the password (Default Password: 2-8-4)	<div style="border: 1px solid black; padding: 5px;"> <p style="text-align: center;">Enter Password</p> <hr/> <table style="width: 100%; border-collapse: collapse;"> <tr> <td style="width: 60%; text-align: center;">Number 1</td> <td style="width: 40%; text-align: center;">2</td> </tr> <tr> <td style="border-top: 1px solid black; text-align: center;">Number 2</td> <td style="border-top: 1px solid black; text-align: center;">8</td> </tr> <tr> <td style="border-top: 1px solid black; text-align: center;">Number 3</td> <td style="border-top: 1px solid black; text-align: center;">4</td> </tr> <tr> <td colspan="2" style="text-align: center; background-color: #0000FF; color: white; padding: 5px;">Submit Password</td> </tr> <tr> <td colspan="2" style="text-align: center; padding: 5px;">Return to System Menu</td> </tr> </table> </div>	Number 1	2	Number 2	8	Number 3	4	Submit Password		Return to System Menu	
Number 1	2											
Number 2	8											
Number 3	4											
Submit Password												
Return to System Menu												
4.	Select Sensor Calibrations	<div style="border: 1px solid black; padding: 5px;"> <p style="text-align: center;">Advanced Settings</p> <hr/> <p style="text-align: center;">Set Time / Date</p> <div style="background-color: #0000FF; color: white; text-align: center; padding: 5px; margin: 5px 0;">Sensor Calibrations</div> <p style="text-align: center;">Change Language</p> <hr/> <p style="text-align: center;">Change Password</p> <hr/> <p style="text-align: center;">Return to System Menu</p> </div>										
5.	Select Calibrate Carrier Angle and then follow the instructions on the screen to complete the calibration. Repeat for Calibrate Boom Angle and Calibrate Boom Length.	<div style="border: 1px solid black; padding: 5px;"> <p style="text-align: center;">Sensor Calibration Menu</p> <div style="background-color: #0000FF; color: white; text-align: center; padding: 5px; margin: 5px 0;">Calibrate Carrier Angle</div> <p style="text-align: center;">Calibrate Boom Angle</p> <hr/> <p style="text-align: center;">Calibrate Boom Length</p> <hr/> <p style="text-align: center;">Return to Advanced Menu</p> </div>										

Table 21: Sensor Calibration

Schematics

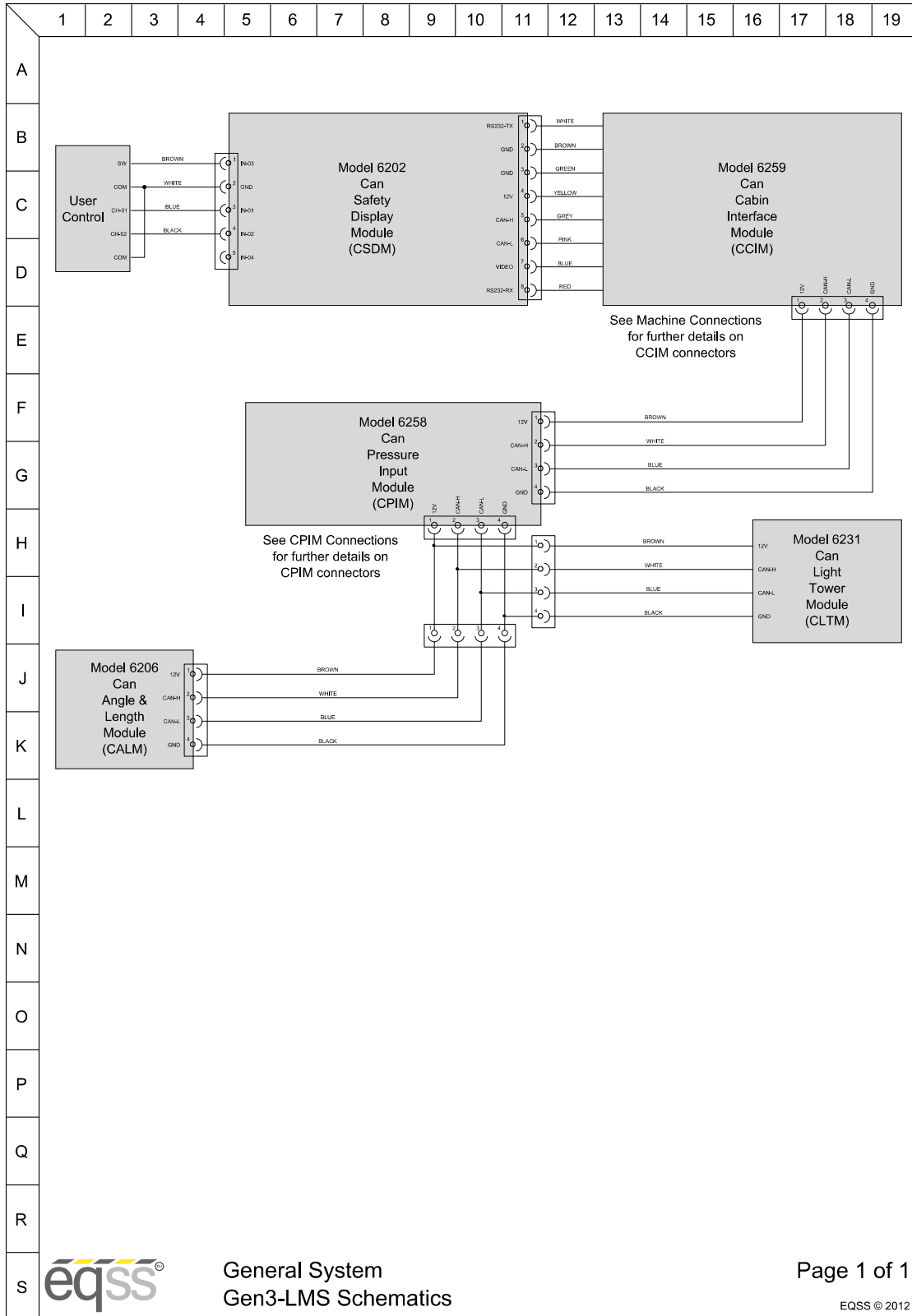

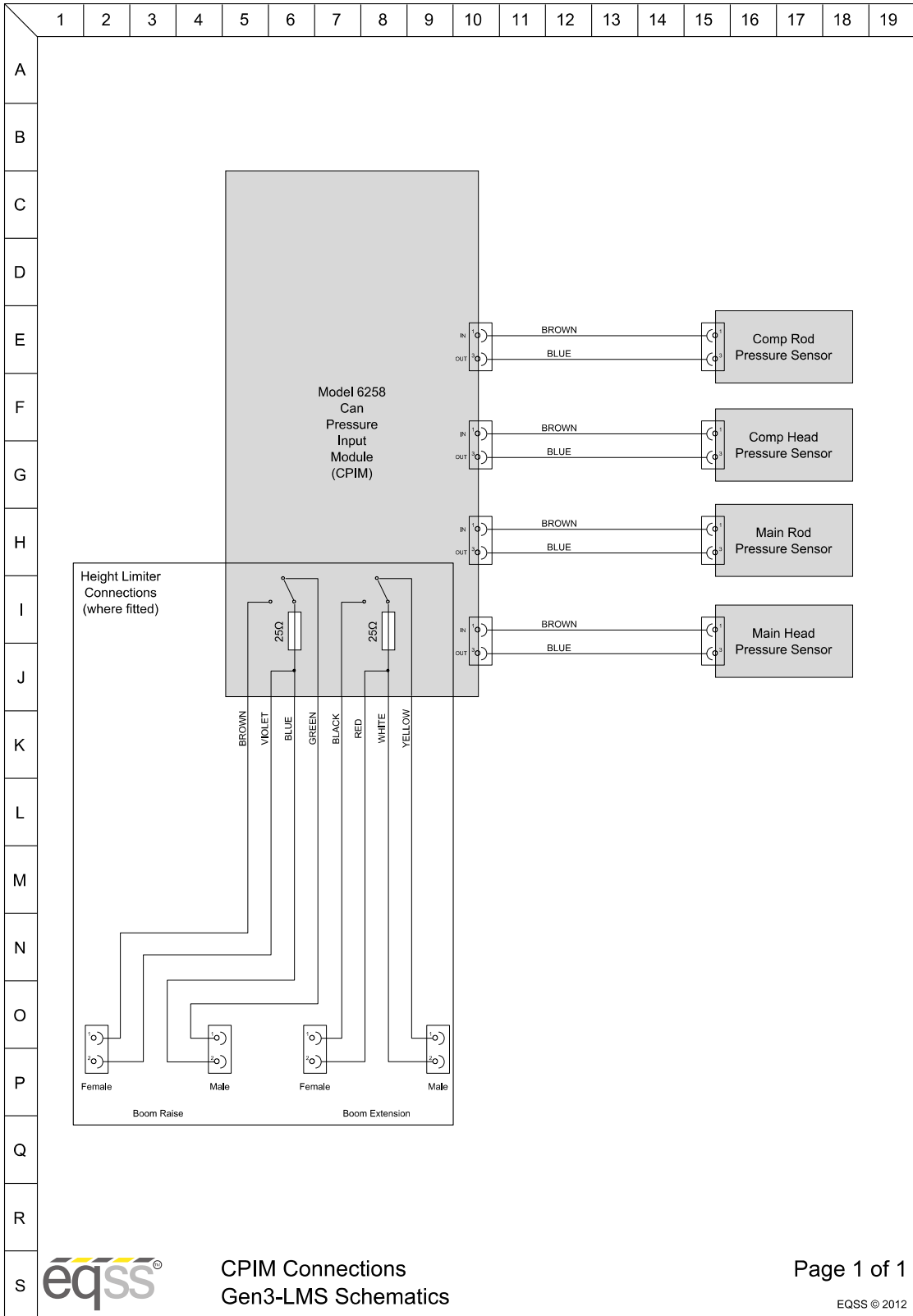

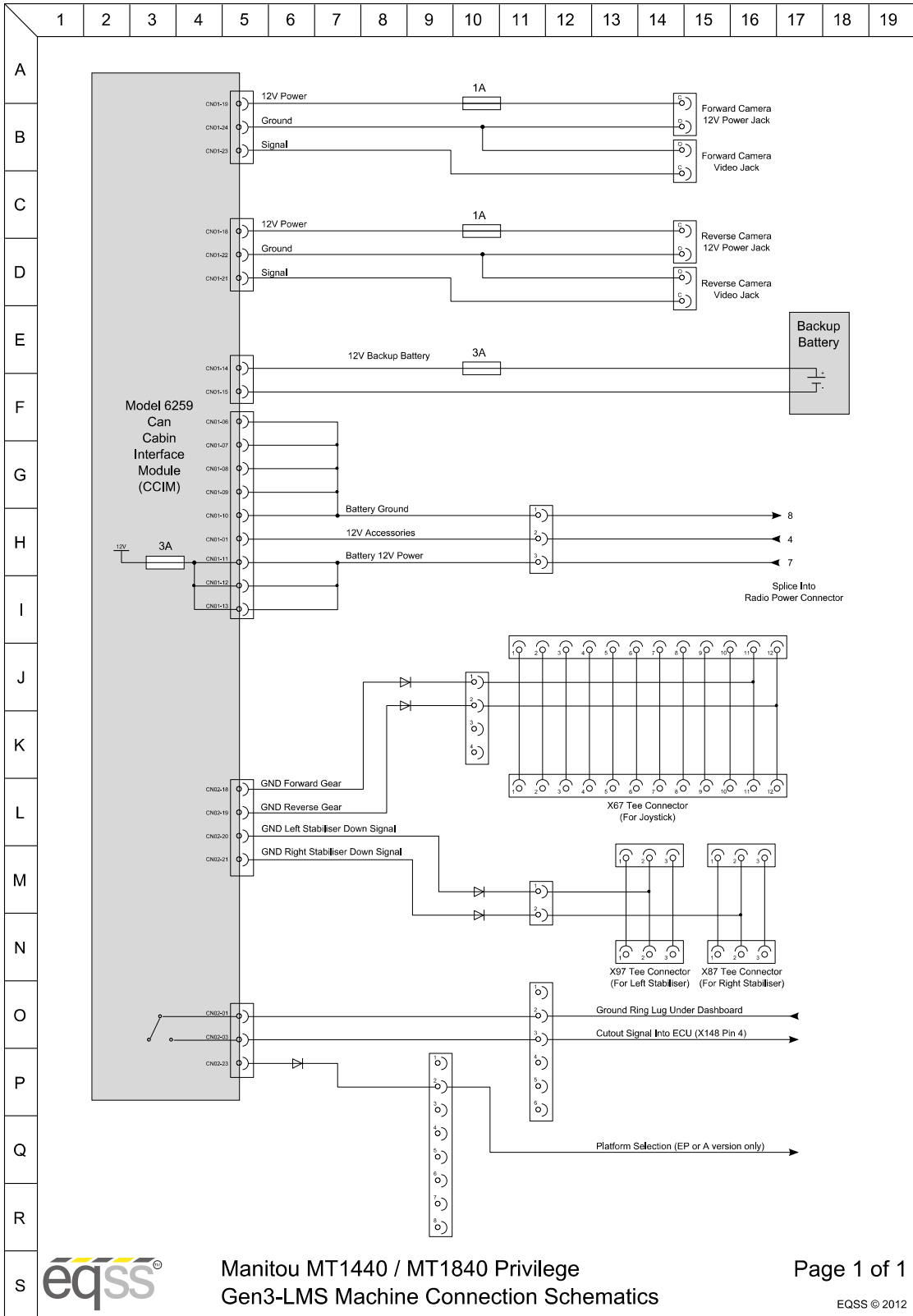

Indexes and Tables

Illustration Index

Illustration 1: Machine Boom.....	9
Illustration 2: Machine Chassis.....	10
Illustration 3: Front of Machine.....	11
Illustration 4: Cable Reeler Mounting Position New Picture required for MT1440.....	18
Illustration 5: ID Reader Mounting Position.....	22
Illustration 6: Light Tower Bracket Mounting Position.....	35

Index of Tables

Table 1: Component Installation Index.....	7
Table 2: Cable Installation Index.....	8
Table 3: Cover removal.....	13
Table 4: Cable Reeler Installation.....	17
Table 5: ID Reeler Installation.....	21
Table 6: Pressure Manifold Installation.....	24
Table 7: Compensation Pressure Sensor Installation.....	25
Table 8: Reverse Camera Installation.....	26
Table 9: Rear Cable Harness Installation.....	30
Table 10: Forward Camera Installation.....	31
Table 11: Stabiliser Cable Harness Installation.....	33
Table 12: Light Tower Installation.....	34
Table 13: Joystick Cable Harness Installation.....	36
Table 14: Can Pressure Input Module (CPIM) Installation.....	37
Table 15: External Cable Completion.....	39
Table 16: Display Installation.....	40
Table 17: User Input Control Installation.....	41
Table 18: CCIM Installation.....	42
Table 19: Cabin Loom Installation.....	45
Table 20: Finalisation.....	48
Table 21: Sensor Calibration.....	50

Equipment Safety Systems Pty. Ltd. ABN: 31 061 789 151
27 Cumberland Drive, Seaford 3198, Victoria, Australia

Tel: +61 3 8770 6555
Fax: +61 3 8770 6590
Web: www.eqss.com.au