



eqss™ Gen-3 LMS Telehandler Load Management System

Installation Manual for MT1033 Manual Tool Recognition



*****Do Not Swap Components between Gen3-LMS kits*****

When installing multiple Gen3-LMS kits, make sure the serial number on the sticker matches the serial number on the machine.

*****Failure To Follow Installation Manual Will Void Warranty*****

Documentation Conventions

The list below highlights important documentation conventions.



Text presented in this manner is intended to provide the user with some general information. The user should ensure information presented in this manner is clearly understood.



Text presented in this manner provides the user with information to assist in completion of the current procedure being explained.



Text presented in this manner indicates that a failure to follow directions could result in damage to equipment, loss of information, bodily harm, or loss of life.

Important Information

Information contained in this publication regarding this device's applications and the like is provided only for your convenience and may be superseded by updates. It is your responsibility to ensure that the application or our equipment meets with your specifications.

EQUIPMENT SAFETY SYSTEMS MAKE NO REPRESENTATIONS OR WARRANTIES OF ANY KIND WHETHER EXPRESS OR IMPLIED, WRITTEN OR ORAL, STATUTORY OR OTHERWISE, RELATED TO THE INFORMATION, INCLUDING BUT NOT LIMITED TO, IT'S CONDITION, QUALITY, PERFORMANCE, MERCHANTABILITY OR FITNESS FOR PURPOSE.

Equipment Safety Systems disclaims all liability arising from this information and its use. Use of Equipment Safety Systems' products as critical components in life support systems is not authorised except with express written approval by Equipment Safety Systems. No licenses are conveyed, implicitly or otherwise, under any Equipment Safety Systems intellectual property rights.

Table of Contents

Tools Required for Installation.....	6
Installation Index.....	7
Covers.....	11
Cable Reeler Installation.....	13
Cable Reeler Mounting Position.....	15
Pressure Sensor Installation.....	16
Pressure Manifold.....	16
Compensation Pressure Sensors.....	18
Reverse Camera.....	19
SPU Cable Harness.....	21
Forward Camera.....	23
Stabiliser Cable Harness.....	25
Light Tower Installation.....	27
Light Tower Bracket Mounting Position.....	28
Joystick Cable Harness.....	29
Can Pressure Input Module (CPIM).....	30
External Cable Completion.....	31
Display Installation.....	33
User Control.....	34
Can Cabin Interface Module (CCIM).....	35
Cabin Loom.....	36
Finalisation.....	39
Set Time & Sensor Calibration.....	42
Schematics.....	45
Appendix A: Attaching Display Connectors.....	48

Appendix B: Reattach Ferrites.....52
Indexes and Tables.....53

Tools Required for Installation

The tools required to perform the installation of the Gen3-LMS are listed below

- Pencil or Texta
- Drill
- Drill bits
 - 3.3 mm
 - 4.5 mm
 - 5 mm
 - 6.25 mm
 - 6.8 mm
 - 8.5 mm
- Centre punch
- Tap T-Handle
- Taps
 - M6
 - M7 x 0.75
 - M8
- Drill and tap oil
- Metric Allen keys
- Phillips Head screw driver
- Spanners and sockets
 - 7 mm
 - 10 mm
 - 13 mm
- Loctite thread locker
- Side cutters
- Stanley knife
- Crimpers
- Wire strippers

Installation Index

The components and cables of the Gen-3 Telehandler Load Management System are outlined in the tables below. The following pages show where the components are installed and the cable routing.

See the appropriate manual section for a detailed installation description for each component.



Refer to this section for any component placement or cable routing issues

<i>Item</i>	<i>Component Description</i>
1	Cable Reeler
2	Main Lift Cylinder Pressure Sensors
3	Compensation Cylinder Pressure Sensors
4	Can Pressure Input Module (CPIM)
5	Forward Camera
6	Light Tower
7	Rear Camera
8	Can Cabin Interface Module (CCIM)
9	Display Module
10	SPU Module
11	Stabiliser Connections
12	Joystick Connections (X43)

Table 1: Component Installation Index

<i>Colour</i>	<i>Cable Description</i>
Yellow	Boom Cable
Dark Green	Main Cylinder Pressure Sensor Cables
Dark Blue	Compensation Cylinder Pressure Sensors Cables
Light Blue	Forward Camera Cable
Violet	Signal Light Cable
Aqua	Rear Camera Cable
Dark Purple	CCIM Cable
Light Green	Cutout Harness
Red	Display Cable
Orange	User Control Cable
Brown	Machine Input Harness
Dark Yellow	Stabiliser Harness

Table 2: Cable Installation Index



Cable tie to
hydraulic lines

Illustration 1: Machine Boom

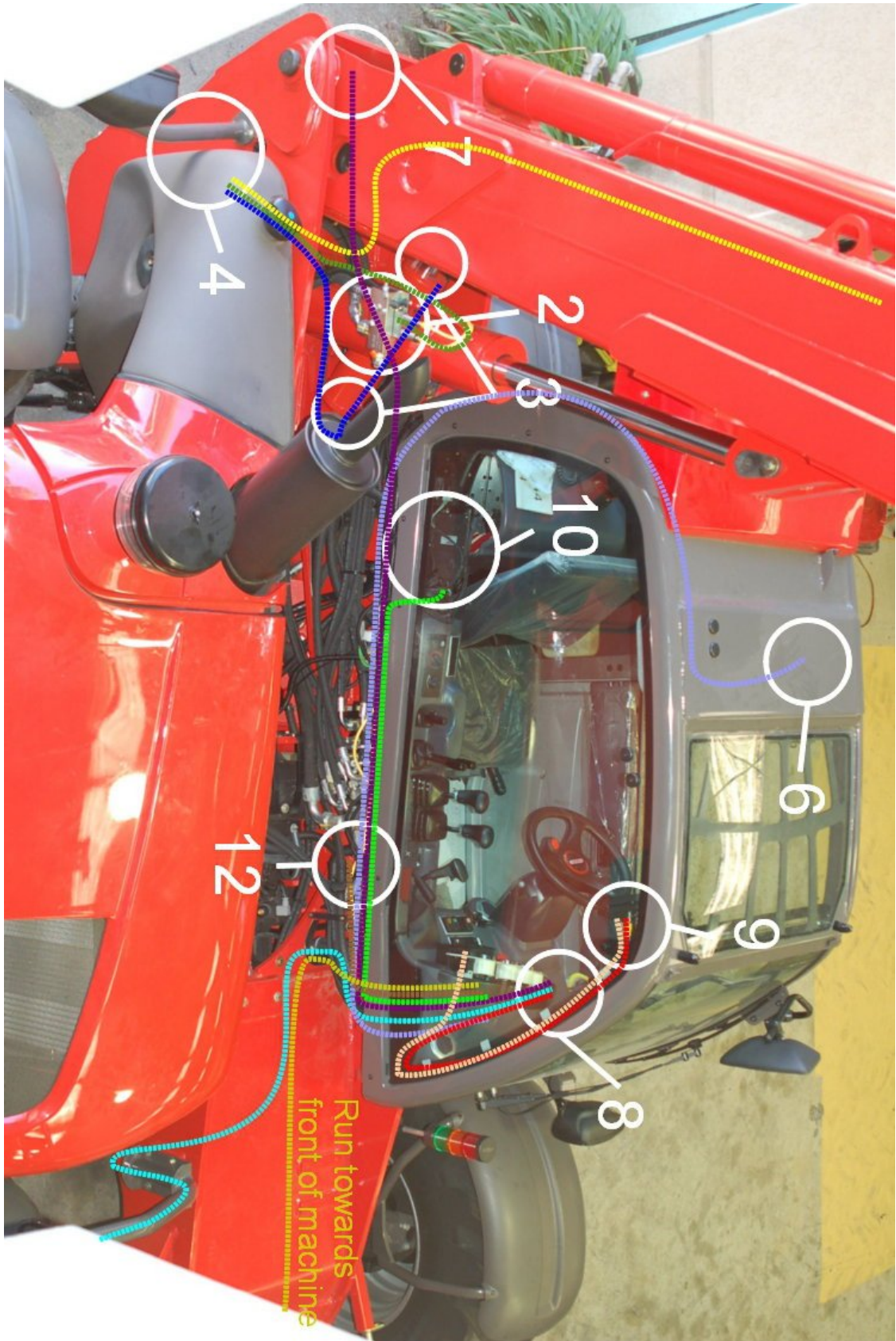





Illustration 2: Machine Chassis

Note: The old light tower is shown

Covers

Remove the following covers before starting the installation

<i>Step</i>	<i>Description</i>	<i>Diagram</i>
1.	Remove the top and lower rear cover behind the boom.	
2.	Remove the side panel next to the cabin under the boom.	
3.	Remove the covers under the boom. Remove the covers over the stabiliser pressure manifolds	



<i>Step</i>	<i>Description</i>	<i>Diagram</i>
4.	Inside the cabin remove the dashboard.	
5.	Remove the cover over the fluid containers	
6.	Remove the cover over the SPU behind the seat	

Table 3: Cover removal

Cable Reeler Installation

The cable reeler is used to measure the boom extension to determine the maximum lifting capacity.



A false N07 fault can occur if the boom jumps off the stow switch due to pressurising the hydraulic system and without operating the boom extension control. Ensure the stow switch arm is correctly adjusted to prevent this error.

<i>Step</i>	<i>Description</i>	<i>Diagram</i>
1.	<p>Drill and tap the holes for the cable reeler according to the mounting diagram on page 15.</p> <p>Mount using the supplied bolts and washers.</p>	
2.	<p>Drill and tap an M8 hole for the cable anchor. Ensure the cable anchor is positioned so the cable runs in line with the boom.</p> <p>Mount the cable anchor and attach the cable.</p>	
3.	<p>Drill and tap the M6 holes for the stow switch trigger bracket.</p> <p>Mount the stow switch trigger bracket using the supplied bolts and washers.</p> <p>Adjust the length of the trigger plate to ensure the stow switch is pressed when the boom is retracted.</p>	



<i>Step</i>	<i>Description</i>	<i>Diagram</i>
4.	Connect the supplied M12 10 metre cable (CB001027) into the cable reeler connection.	
5.	<p>Run the cable along the hydraulic pipes running down the boom, secure using cable ties every 150 mm to 200 mm.</p> <p>Cable tie to the flexible hydraulic hoses down to the chassis. Make sure the cable isn't pinched or stretched when the boom is raised or lowered.</p> <p>Run the remainder of the cable out the hole below the lift cylinder towards the rear of the machine and cable tie with the other cables during External Cable Completion on page 31.</p>	

Table 4: Cable Reeler Installation



For further details on running the boom cable refer to the Installation Index on page 7

Cable Reeler Mounting Position

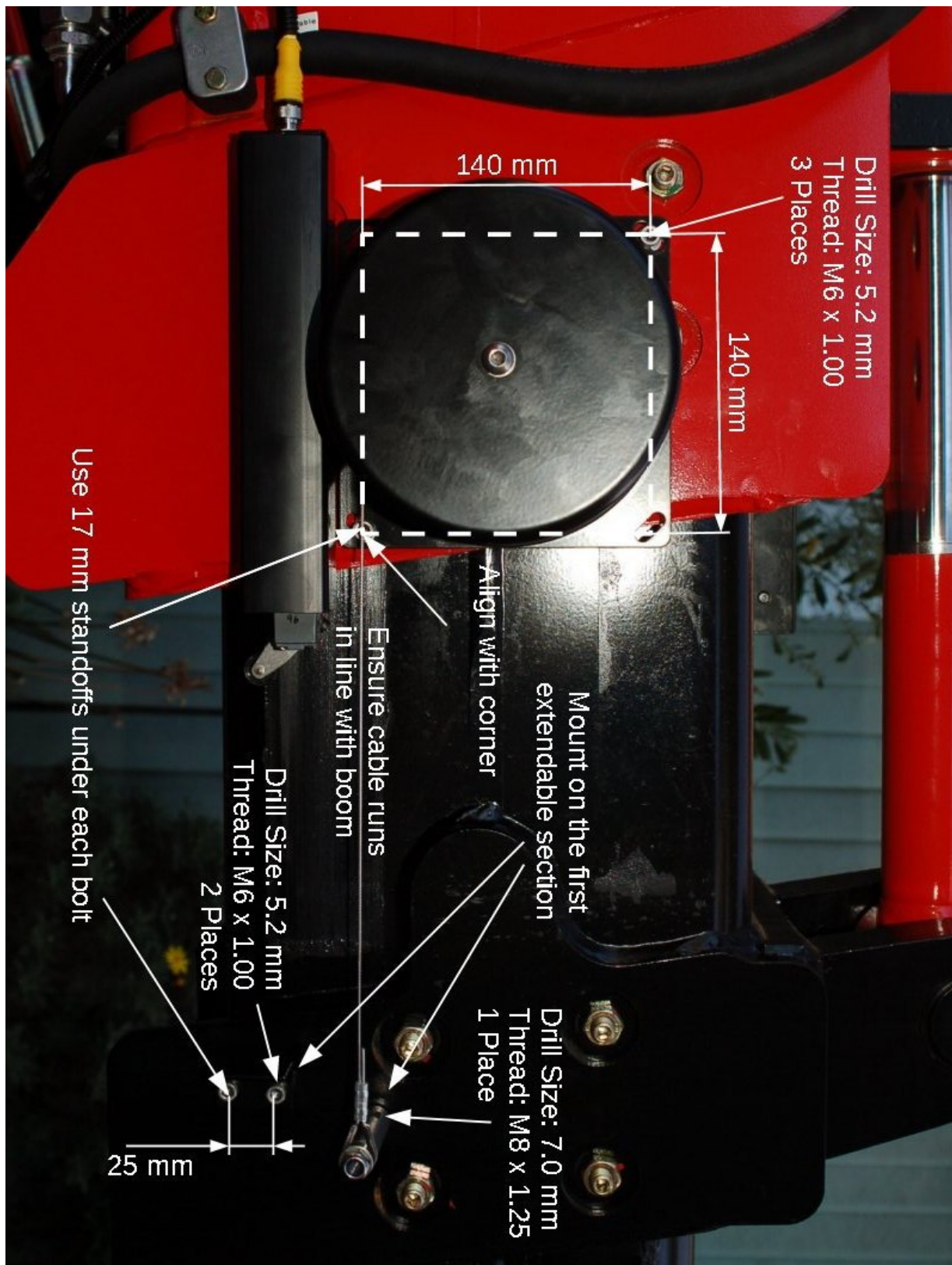



Illustration 3: Cable Reeler Mounting Position

Pressure Sensor Installation

The hydraulic pressure sensors are used to measure the lifting load of the telehandler.

Pressure Manifold

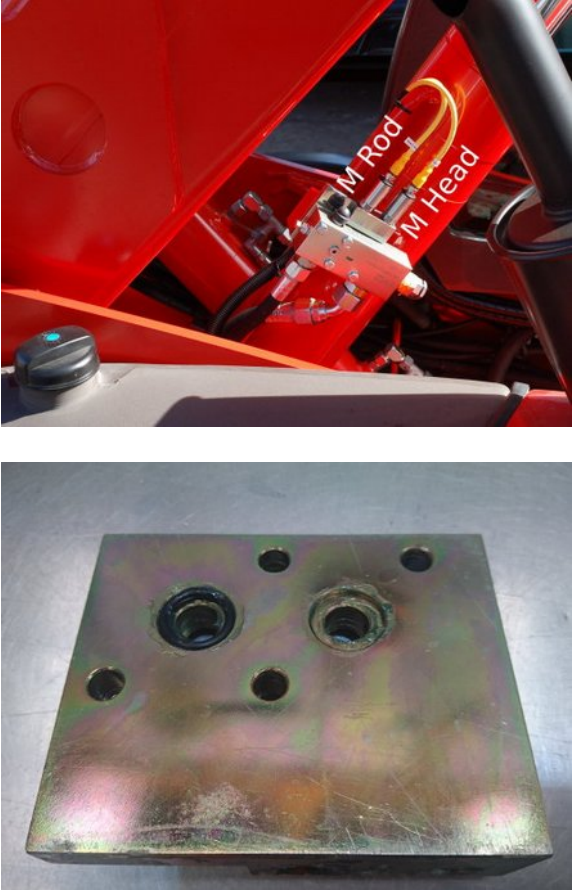

Failure to tighten the bolts to the correct torque on the pressure manifold may result in a pressure failure on the counterbalance valve causing an uncontrolled fall of the boom.

<i>Step</i>	<i>Description</i>	<i>Diagram</i>
1.	<p>Raise the boom to approximately 40 degrees.</p> <p>Support and secure the boom using an A Frame or similar apparatus. It must support at least 2 tons.</p> <p>Apply the handbrake and insert chock under wheels.</p> <p>Remove the counterbalance valve on the side of the hydraulic lifting ram.</p> <p>Removing the counterbalance valve will release the hydraulic pressure which may result in a spray of oil.</p> <p>Secure the pressure manifold using the supplied 70 mm bolts and seals. Tighten the bolts for the manifold to 25 NM using a torque wrench.</p> <p>Start the machine, pressurise the boom and check for leaks.</p>	 <p>Use lube on seals to hold in place during mounting</p>



<i>Step</i>	<i>Description</i>	<i>Diagram</i>
2.	<p>Connect the supplied M12 4 metre cables (CB001026) into each of the pressure sensors.</p> <p>Add both cables to 3 m of snake tube. Cable tie to the flexible hydraulic hoses connected to the main lift cylinder. Make sure the cable isn't pinched or stretched when the boom is raised or lowered.</p> <p>Run the remainder of the cable out the hole above the rear axle under the lift cylinder towards the rear of the machine and cable tie with the other cables during External Cable Completion on page 31.</p> <p>Ensure the pressure sensors and cables do not collide with the boom and chassis structures and the cables do not stretch or pinch when the boom is raised and lowered.</p>	

Table 5: Pressure Manifold Installation



For further details on running the pressure sensor cables refer to the Installation Index on page 7

Compensation Pressure Sensors



<i>Step</i>	<i>Description</i>	<i>Diagram</i>
1.	<p>Install the pressure sensors with the tee connections into the head and rod of the compensation cylinder.</p> <p>Start the machine, pressurise the boom and check for leaks.</p> <p>Connect the supplied M12 4 metre cables (CB001026) into each of the pressure sensors.</p> <p>Add both cables to 3 m of snake tube.</p> <p>Run the remainder of the cable out the hole above the rear axle under the lift cylinder towards the rear of the machine and cable tie with the other cables during External Cable Completion on page 31.</p> <p>Ensure the pressure sensors and cables do not collide with the boom and chassis structures and the cables do not stretch or pinch when the boom is raised and lowered.</p>	 <p>View from behind the cabin towards the rear of the machine</p>

Table 6: Compensation Pressure Sensor Installation

 For further details on running the pressure sensor cables refer to the Installation Index on page 7

Reverse Camera

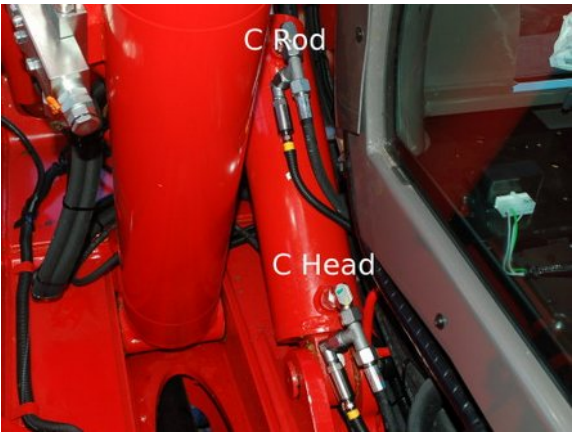
The rear camera video is displayed on the screen when the machine is in reverse gear to allow the operator to see behind the telehandler while reversing.



Do not disconnect the camera power connection while the system is operating as this can damage the fuse.

<i>Step</i>	<i>Description</i>	<i>Diagram</i>
1.	Drill a 31mm hole in the location shown. Insert the camera through the hole and adjust the angle using the alignment washers.	
2.	Place the supplied high pressure warning decal next to the reverse camera.	

<i>Step</i>	<i>Description</i>	<i>Diagram</i>
3.	<p>Connect the camera power and signal connectors to the supplied 5m camera cable (CB001032).</p> <p>Note; The white connector is not used.</p> <p>Secure the camera cable using a single cable tie to maintain the connector location.</p> <p>Run the remainder of the cable towards the cabin and cable tie with the other cables during External Cable Completion on page 31.</p>	

Table 7: Reverse Camera Installation



The camera's viewing angle may need to be adjusted once the system is installed and the display is operational.

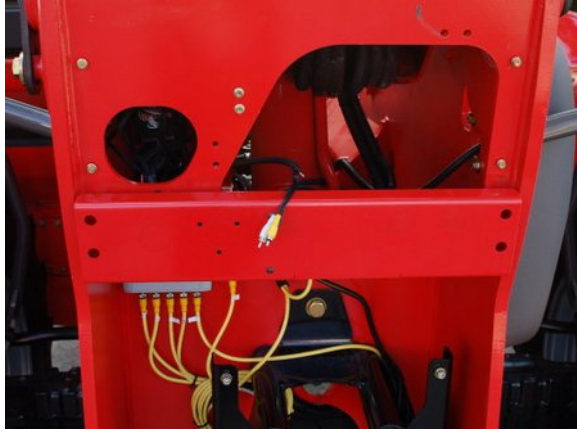

Once the cable has secured with a cable tie disconnect the cable to remove the rear cover until the installation is finalised



For further details on running the camera cable refer to the Installation Index on page 7

SPU Cable Harness



Isolate the main battery before connecting into the machine wiring

<i>Step</i>	<i>Description</i>	<i>Diagram</i>
1.	<p>Push the snake tube containing the terminal for the SPU connector cutout signal from under the boom through the hole into the cabin with the other snake tube cables for the SPU.</p> <p>Cable tie the snake tube into the existing tube going into the seal.</p>	
2.	<p>Remove the connectors from the SPU and insert the cutout terminal into A22 (where A is the smaller connector).</p> <p>Note: If there is already a terminal in this position splice the cutout signal into this terminal wire.</p> <p>Cable tie to the SPU snake tube.</p>	
3.	<p>Run the snake tube and cables towards the cabin and cable tie with the other cables during External Cable Completion on page 31.</p>	

Table 8: SPU Cable Harness Installation



For further details on running the spu cable harness refer to the Installation Index on page 7

Forward Camera

The forward camera video is displayed on the screen when the machine is in forward gear to allow the operator to see past the boom to obstructions that would damage the right front tyre.



Do not disconnect the camera power connection while the system is operating as this can damage the fuse.

<i>Step</i>	<i>Description</i>	<i>Diagram</i>
1.	<p>Mount the camera to the side mirror using the p-clips as shown.</p> <p>Secure using two M6 nuts.</p>	
2.	<p>Connect the camera power and signal connectors to the supplied 5m camera cable (CB001032).</p> <p>Note; The white connector is not used.</p> <p>Run the cable along the same path as the headlight cable, run it through the headlight post, then under the chassis to the side of the cabin. Cable tie to the headlight cable every 150 mm to 200 mm.</p> <p>Complete the cable installation during External Cable Completion on page 31.</p>	

Table 9: Forward Camera Installation



The camera's viewing angle may need to be adjusted once the system is installed and the display is operational.



For further details on running the camera cable refer to the Installation Index on page 7

Stabiliser Cable Harness

The pressure switches don't come with the MT1030 as standard and will need to be order from Manitou.

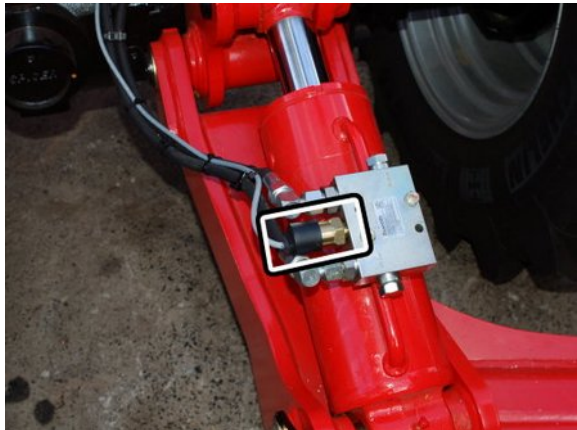
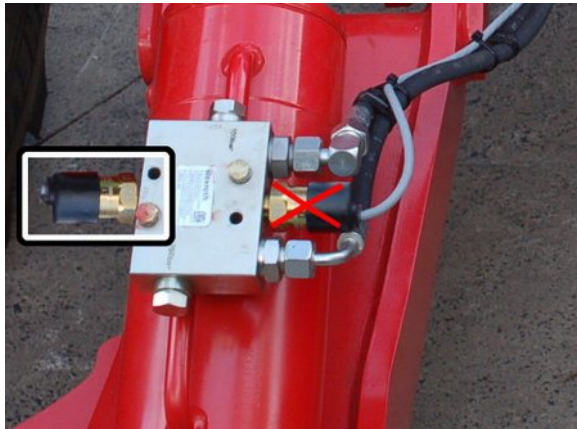
<i>Step</i>	<i>Description</i>	<i>Diagram</i>
1.	Remove the blanking plug from the pressure manifold and install the pressure switch, into the left stabiliser	
2.	<p>The pressure port for the right stabiliser manifold block may not be connected to the head of the cylinder.</p> <p>If this is the case the manifold will need to be removed and a thread drilled into the other side of the manifold connecting to the head of the cylinder.</p> <p>The cover will also need to be modified to protect the pressure switch.</p>	



<i>Step</i>	<i>Description</i>	<i>Diagram</i>
3.	<p>Connect the 3 pin connector labelled left stabiliser from the stabiliser harness into the left stabiliser pressure switch.</p> <p>Connect the 3 pin connector labelled right stabiliser from the stabiliser harness into the right stabiliser pressure switch.</p> <p>Cable tie to the existing snake tube.</p> <p>Run the remainder of the cable towards the cabin and cable tie with the front camera cable harness during External Cable Completion on page 31.</p>	

Table 10: Stabiliser Cable Harness Installation



For further details on running the stabiliser cable harness refer to the Installation Index on page 7

Light Tower Installation

The light tower warns other workers when the telehandler is lifting loads close to it's maximum capacity.

<i>Step</i>	<i>Description</i>	<i>Diagram</i>
1.	<p>Drill and tap the holes required to mount the light tower bracket on the chassis according to the mounting diagram on page 28.</p> <p>Secure using the supplied bolts as described on page 28.</p> <p>Run the cable through the gap between the chassis and the cabin towards the side of the cabin.</p> <p>Complete the cable installation during External Cable Completion on page 31.</p>	

Table 11: Light Tower Installation



For further details on running the light tower cable refer to the Installation Index on page 7

Light Tower Bracket Mounting Position

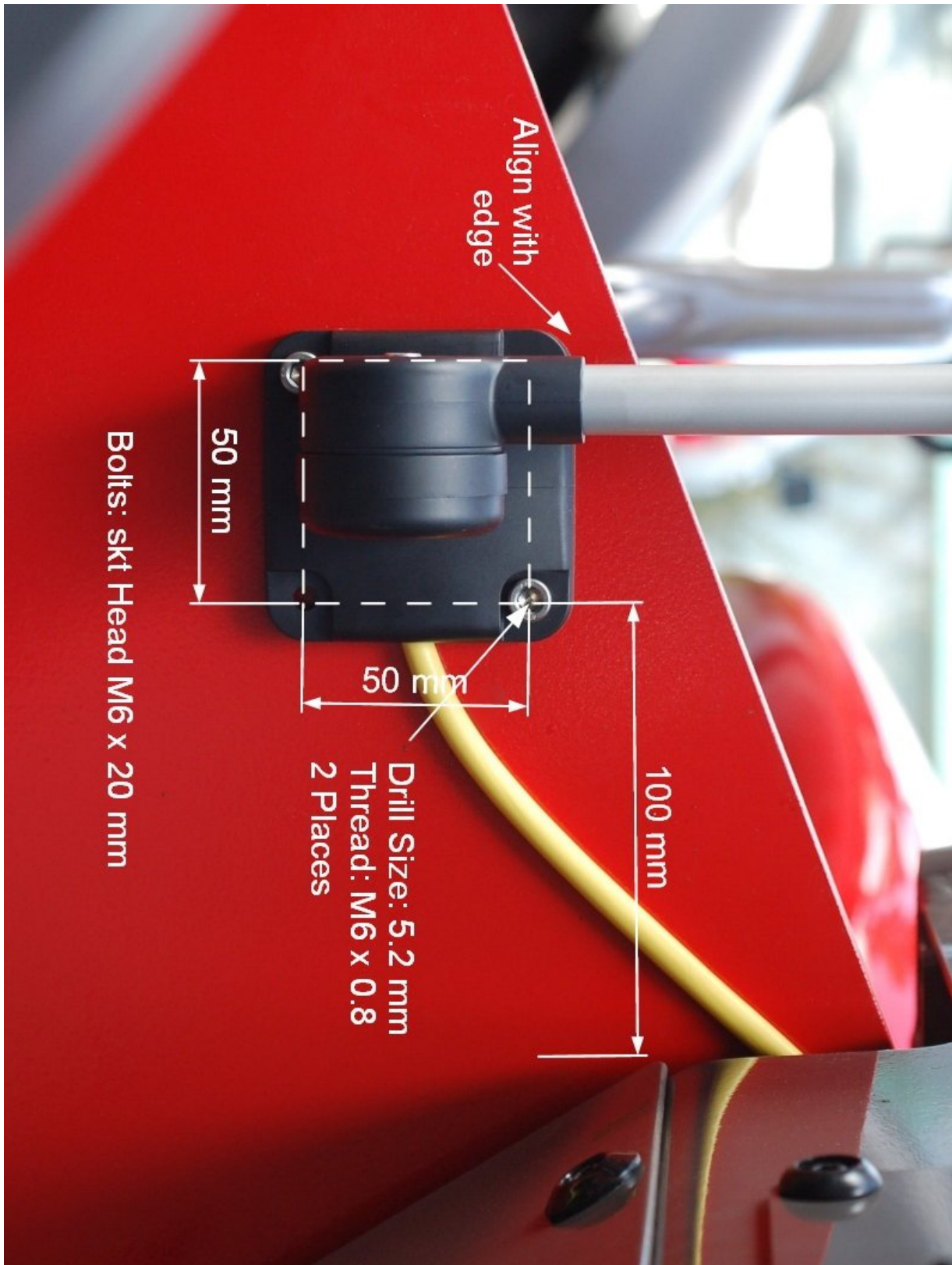

Illustration 4: Light Tower Bracket Mounting Position

Joystick Cable Harness



Isolate the main battery before connecting into the machine wiring

<i>Step</i>	<i>Description</i>	<i>Diagram</i>
1.	<p>Locate the connectors under the boom next to the cabin, that connect into the joystick.</p> <p>Connect the 12 pin tee connector from the machine input harness into the 12 pin connector into the joystick.</p> <p>Run the cable towards the cabin and cable tie with the other cables during External Cable Completion on page 31.</p>	

Table 12: Joystick Cable Harness Installation



For further details on running the joystick cable harness refer to the Installation Index on page 7

Can Pressure Input Module (CPIM)

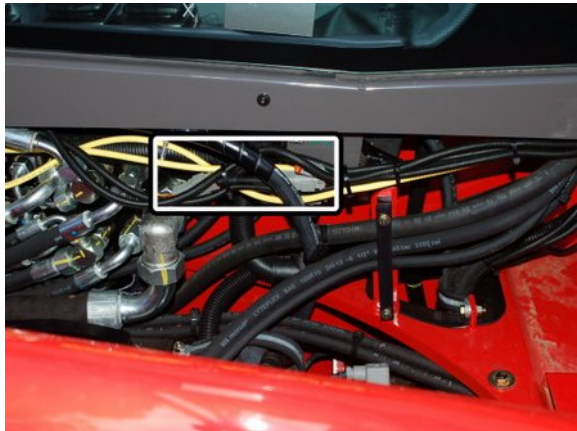
The CPIM is responsible for processing the information sent from the pressure sensors.



Accidentally swapping the pressure sensor connections will not damage system and can be determined if the display is showing a negative load.



Do not plug the pressure sensor cable into the far right side boom cable. This will damage the system.





<i>Step</i>	<i>Description</i>	<i>Diagram</i>
1.	<p>Drill and tap two M8 holes for the CPIM bracket in the chassis rear panel.</p> <p>Mount using the supplied M8 x 12mm bolts and washers.</p>	
2.	<p>Connect the cables for the pressure sensors and boom cable to the CPIM according to the picture shown.</p> <p>Note: The CCIM cable will be installed during External Cable Completion on page 31.</p>	

Table 13: Can Pressure Input Module (CPIM) Installation

External Cable Completion

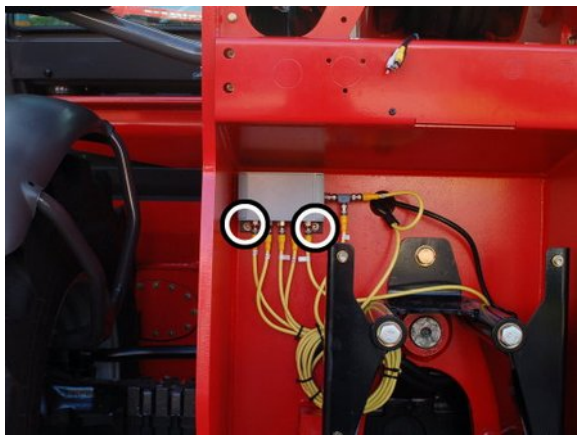
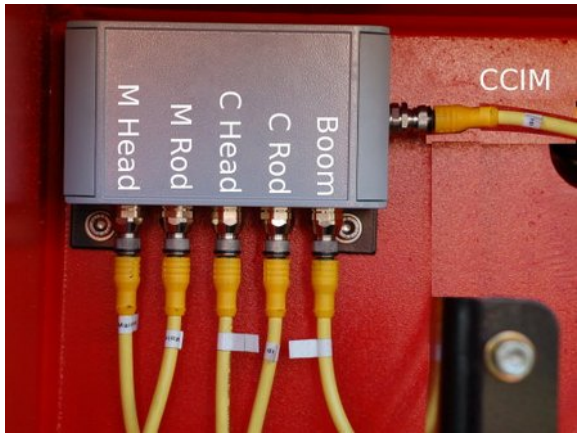
All external cabling is completed in this step.

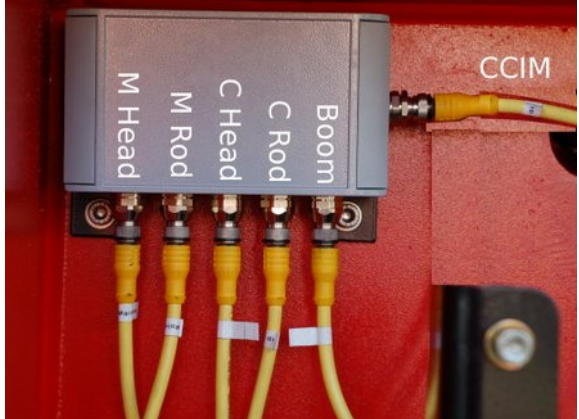
<i>Step</i>	<i>Description</i>	<i>Diagram</i>
1.	Coil up and cable tie the additional cabling for the pressure sensor, and boom cables and store underneath the CPIM.	
2.	<p>Connect the supplied M12 4 metre cable (CB001026) into the connection out of the right side of the CPIM for the CCIM cable.</p> <p>Run the cable out the hole under the lift cylinder.</p>	
3.	Cable tie the CCIM, signal light, rear camera, cutout and machine input harnesses together along the side to the front of the cabin.	

<i>Step</i>	<i>Description</i>	<i>Diagram</i>
4.	<p>Run the CCIM, signal light, cutout harness, stabiliser cable harness and camera cables up through the hole into the cabin under the dashboard.</p> <p>Note: Pull the entire length of cable through into the cabin, excess cable will be stored under the dashboard cover in the cabin.</p>	

Table 14: External Cable Completion



For further details on running the cables refer to the Installation Index on page 7

Display Installation

The display shows the current safety status of the telehandler.

<i>Step</i>	<i>Description</i>	<i>Diagram</i>
1.	<p>Attach the display bracket to the level indicator in the top right corner using the supplied M6 x 35 mm bolts and nuts.</p> <p>Attach the display to the bracket and tighten the grub screw</p>	

Table 15: Display Installation



Adjust the display bracket for optimal viewing angle once the display is powered



If the M12 screw lock connectors on the display are over tightened it will twist the connector pins attaching the connector to the PCB. See Appendix A: Attaching Display Connectors on page 48 for the correct method of attaching to the display connectors.



If the clip-on ferrites were removed from the CCIM and user control cables. See Appendix B: Reattach Ferrites and page 52 for the correct reattachment position.

User Control

The user control consists of a 5 button switch mounted in the dashboard.



<i>Step</i>	<i>Description</i>	<i>Diagram</i>
1.	<p>Drill a 39 mm hole into the cover in front of the joystick and install the user control dial.</p> <p>Note: Be careful while drilling not to damage the hydraulic controls positioned under the cover.</p>	
2.	<p>Run the cable through under the dashboard with the other cables.</p>	

Table 16: User Input Control Installation



If the M12 screw lock connectors on the display are over tightened it will twist the connector pins attaching the connector to the PCB. See Appendix A: Attaching Display Connectors on page 48 for the correct method of attaching to the display connectors.

Can Cabin Interface Module (CCIM)

The CCIM connects the system into the machine electronics.





<i>Step</i>	<i>Description</i>	<i>Diagram</i>
1.	Position the backup battery underneath the dashboard as shown and secure using double sided velcro tape.	 <p>The diagram shows the interior of a machine's cabin, specifically the area under the dashboard. A small, rectangular backup battery is mounted on a surface. It is secured with a piece of double-sided velcro tape. Various wires and components are visible in the background.</p>
2.	<p>Position the CCIM next to the brake fluid container as shown and secure using double sided velcro tape.</p> <p>Remove the CCIM from the velcro to allow the connections to be completed. Reattach to the velcro in the section Finalisation on page 39.</p>	 <p>The diagram shows the interior of a machine's cabin, focusing on the area near the brake fluid container. The CCIM is mounted next to the container, secured with double-sided velcro tape. The brake fluid container is a light blue plastic reservoir. The CCIM is a small, rectangular module with wires connected to it.</p>



Table 17: CCIM Installation

Cabin Loom

The cabin loom connects the CCIM to the machine connections and the other modules of the system.

 Isolate the main battery before connecting into the machine wiring

 Do not disconnect the camera power connection while the system is operating as this can damage the fuse.

<i>Step</i>	<i>Description</i>	<i>Diagram</i>
1.	<p>Connect the CCIM and signal light cables to the M12 connectors on the CCIM.</p> <p>Note: It doesn't matter which of the M12 connectors the CCIM and signal light cables are plugged into.</p>	
2.	<p>Connect the Power/Camera and IO Harnesses to the bulkhead connectors on the CCIM.</p>	



<i>Step</i>	<i>Description</i>	<i>Diagram</i>
3.	<p>Connect the camera power and signal cables to the cabin loom.</p> <p>Note: The white connector is not used.</p>	
4.	<p>Connect the 4 pin female connector from the machine input harness, the 6 pin female connector from the cutout cable harness and the 2 pin and 12 pin connectors from the stabiliser harness to the cabin loom connectors.</p> <p>Note: If stabilisers are not fitted leave the 2 and 12 pin disconnected</p>	
5.	<p>Run the 8 pin cable from the CCIM and 5 pin cable from the user control through the gap between the window and the dashboard.</p> <p>Run both cables through snake tube and attach to the connectors to the back of the display.</p>	
6.	<p>Place cable tie points on the side of the window.</p> <p>Cable tie the snake tube to the cable tie points.</p> <p>Connect the cables to the display. Do not over-tighten the connectors.</p>	

Table 18: Cabin Loom Installation



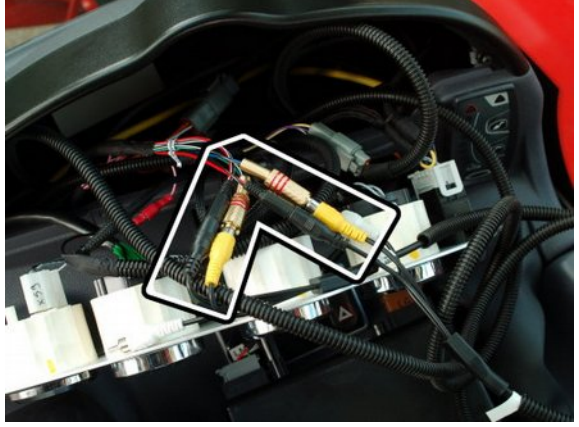
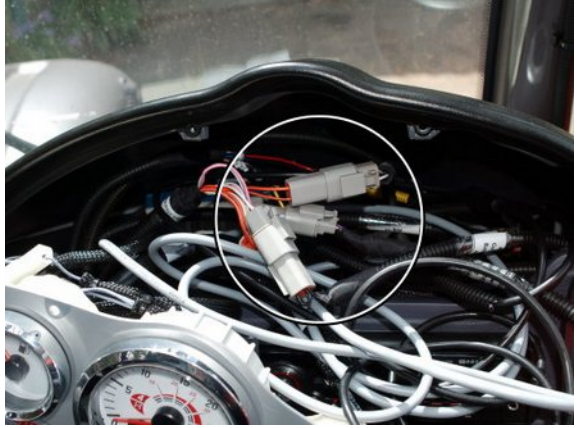

If the M12 screw lock connectors on the display are over tightened it will twist the connector pins attaching the connector to the PCB. See Appendix A: Attaching Display Connectors on page 48 for the correct method of attaching to the display connectors.





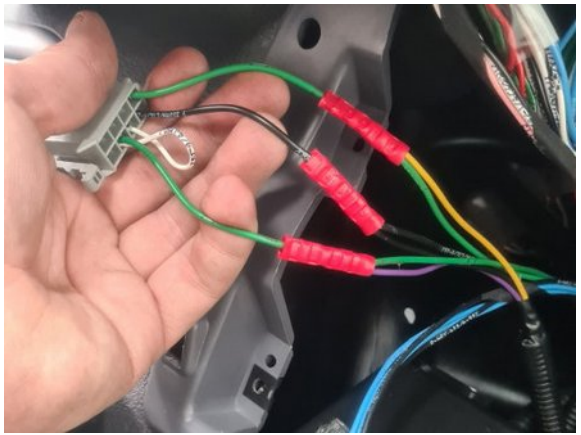

If the clip-on ferrites were removed from the CCIM and user control cables. See Appendix B: Reattach Ferrites and page 52 for the correct reattachment position.

Finalisation

This section will complete the final power connections to power the system and finish any additional items.

<i>Step</i>	<i>Description</i>	<i>Diagram</i>								
1.	<p>Cut wire 478 into terminal 1 of the switch.</p> <p>Join the yellow wire from the machine input harness to side of wire 478 leading towards the switch.</p> <p>Join the violet wire from the machine input harness to the other side of wire 478 leading towards the electronics.</p>									
2.	<p>Splice the wires from the power connector into the grey radio connector according to the table below.</p> <table border="1" data-bbox="306 1120 798 1265"> <thead> <tr> <th><u>Terminal #</u></th> <th><u>Wire Colour</u></th> </tr> </thead> <tbody> <tr> <td>8</td> <td>Black</td> </tr> <tr> <td>4</td> <td>Violet</td> </tr> <tr> <td>7</td> <td>Yellow</td> </tr> </tbody> </table> <p>Secure the splice joins using electrical tape</p> <p>Ensure the correct fuses are installed in the machine's cabin fuse box to enable the radio power.</p>	<u>Terminal #</u>	<u>Wire Colour</u>	8	Black	4	Violet	7	Yellow	 <p>Grey Radio Connector (Plug Side View)</p> 
<u>Terminal #</u>	<u>Wire Colour</u>									
8	Black									
4	Violet									
7	Yellow									

<i>Step</i>	<i>Description</i>	<i>Diagram</i>
3.	<p>Connect the spade lug on the black wire to the negative (black) battery terminal.</p> <p>Connect the spade lug on the blue wire to the positive (red) battery terminal.</p>	
4.	<p>Attach the CCIM to the velcro strips installed earlier.</p>	
5.	<p>Coil up the extra cables and store underneath the dashboard cover.</p> <p>Reconnect the main battery from the isolation switch.</p> <p>Turn the machine onto first stage /accessories and ensure the system is activated.</p>	
6.	<p>Adjust the display bracket for optimal viewing</p> <p>Set the machine into forward gear to activate the forward camera. Adjust the forward camera so the front right wheel is visible.</p> <p>Set the machine into reverse gear to activate the reverse camera. Adjust the reverse camera so the video is level.</p>	



<i>Step</i>	<i>Description</i>	<i>Diagram</i>
7.	<p>Operate the boom movement controls to test if a false N07 fault occurs.</p> <p>If a N07 fault does occur, adjust the arm on the stow switch forwards towards the stow switch trigger.</p> <p>Note: The actual switch arm orientation may differ from the picture.</p>	
8.	<p>Perform a final check on all the cabling and sensors.</p> <p>Replace all the covers</p>	

Table 19: Finalisation

 Make sure to update the machine ECU software for Australian configuration using the Manitou pad.

 Complete the system checklist once installation has been completed.

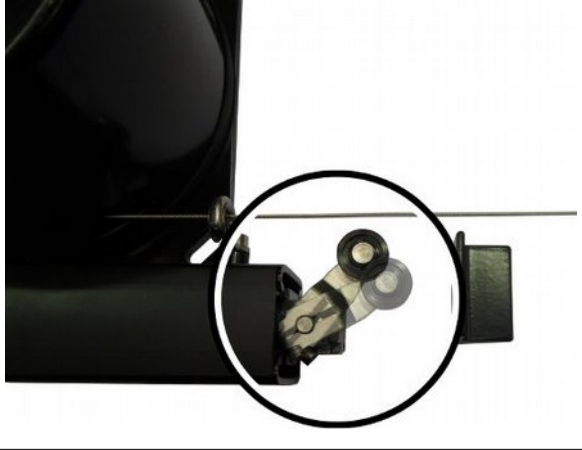
Set Time & Sensor Calibration

Once the installation is complete, the time will need to be set and the sensors will require calibration.



A sensor calibration must be performed once the cable reeler and CPIM have been mounted. If the cable reeler or CPIM have been moved/repositioned a recalibration must be performed

<i>Step</i>	<i>Description</i>	<i>Diagram</i>
1.	<p>Press Enter on the user control dial to enter the menu system.</p> <p>Press the arrow buttons to select System Menu.</p> <p>Press Enter to select the menu.</p>	<div style="border: 1px solid black; padding: 5px;"> <p style="margin: 0;">Main Menu</p> <hr/> <p style="margin: 0;">Attachment Selection Menu</p> <div style="background-color: #4a7ebb; color: white; text-align: center; padding: 5px; margin: 5px 0;">System Menu</div> <p style="margin: 0;">Exit Menu</p> <hr/> </div>
2.	Select Advanced Menu	<div style="border: 1px solid black; padding: 5px;"> <p style="margin: 0;">System Menu</p> <hr/> <p style="margin: 0;">Volume / Brightness</p> <hr/> <p style="margin: 0;">Status Menu</p> <hr/> <p style="margin: 0;">Diagnostics Menu</p> <hr/> <p style="margin: 0;">System Tests</p> <div style="background-color: #4a7ebb; color: white; text-align: center; padding: 5px; margin: 5px 0;">Advanced Menu</div> <p style="margin: 0;">Return to Main Menu</p> <hr/> </div>

<i>Step</i>	<i>Description</i>	<i>Diagram</i>														
3.	Enter the password (Default Password: 2-8-4)	<table border="1"> <thead> <tr> <th colspan="2"><i>Enter Password</i></th> </tr> </thead> <tbody> <tr> <td>Number 1</td> <td>2</td> </tr> <tr> <td>Number 2</td> <td>8</td> </tr> <tr> <td>Number 3</td> <td>4</td> </tr> <tr> <td colspan="2">Submit Password</td> </tr> <tr> <td colspan="2">Return to System Menu</td> </tr> </tbody> </table>	<i>Enter Password</i>		Number 1	2	Number 2	8	Number 3	4	Submit Password		Return to System Menu			
<i>Enter Password</i>																
Number 1	2															
Number 2	8															
Number 3	4															
Submit Password																
Return to System Menu																
4.	Select Set Time / Date	<table border="1"> <thead> <tr> <th colspan="2"><i>Advanced Settings</i></th> </tr> </thead> <tbody> <tr> <td colspan="2">Set Time / Date</td> </tr> <tr> <td colspan="2">Sensor Calibrations</td> </tr> <tr> <td colspan="2">Change Language</td> </tr> <tr> <td colspan="2">Change Password</td> </tr> <tr> <td colspan="2">Return to System Menu</td> </tr> </tbody> </table>	<i>Advanced Settings</i>		Set Time / Date		Sensor Calibrations		Change Language		Change Password		Return to System Menu			
<i>Advanced Settings</i>																
Set Time / Date																
Sensor Calibrations																
Change Language																
Change Password																
Return to System Menu																
5.	<p>Enter the correct time and date for your area.</p> <p>Press the arrow keys to select a time/date parameter</p> <p>Press Enter and the parameter will change to red, press the arrow keys to change the value and then press the Enter key to store the value.</p> <p>Note: The hour parameter is in 24 hour clock</p> <p>Repeat for the rest of the time values</p>	<table border="1"> <thead> <tr> <th colspan="2"><i>Set Time / Date</i></th> </tr> </thead> <tbody> <tr> <td>Hour</td> <td>15</td> </tr> <tr> <td>Minute</td> <td>54</td> </tr> <tr> <td>Day</td> <td>10</td> </tr> <tr> <td>Month</td> <td>2</td> </tr> <tr> <td>Year</td> <td>2016</td> </tr> <tr> <td>Region</td> <td>Melbourne</td> </tr> </tbody> </table>	<i>Set Time / Date</i>		Hour	15	Minute	54	Day	10	Month	2	Year	2016	Region	Melbourne
<i>Set Time / Date</i>																
Hour	15															
Minute	54															
Day	10															
Month	2															
Year	2016															
Region	Melbourne															

<i>Step</i>	<i>Description</i>	<i>Diagram</i>
6.	Scroll to the next page and select Save to store the new time/date and return to the Advanced Menu.	<p>The diagram shows a menu with a blue highlighted button labeled "Save" and a text option "Return to Advanced Menu" below it.</p>
7.	Select Sensor Calibrations	<p>The diagram shows a menu titled "Advanced Settings" with options: "Set Time / Date", "Sensor Calibrations" (highlighted in blue), "Change Language", "Change Password", and "Return to System Menu".</p>
8.	Select Calibrate Carrier Angle and then follow the instructions on the screen to complete the calibration. Repeat for Calibrate Boom Angle and Calibrate Boom Length.	<p>The diagram shows a menu titled "Sensor Calibration Menu" with options: "Calibrate Carrier Angle" (highlighted in blue), "Calibrate Boom Angle", "Calibrate Boom Length", and "Return to Advanced Menu".</p>

Table 20: Sensor Calibration

Schematics

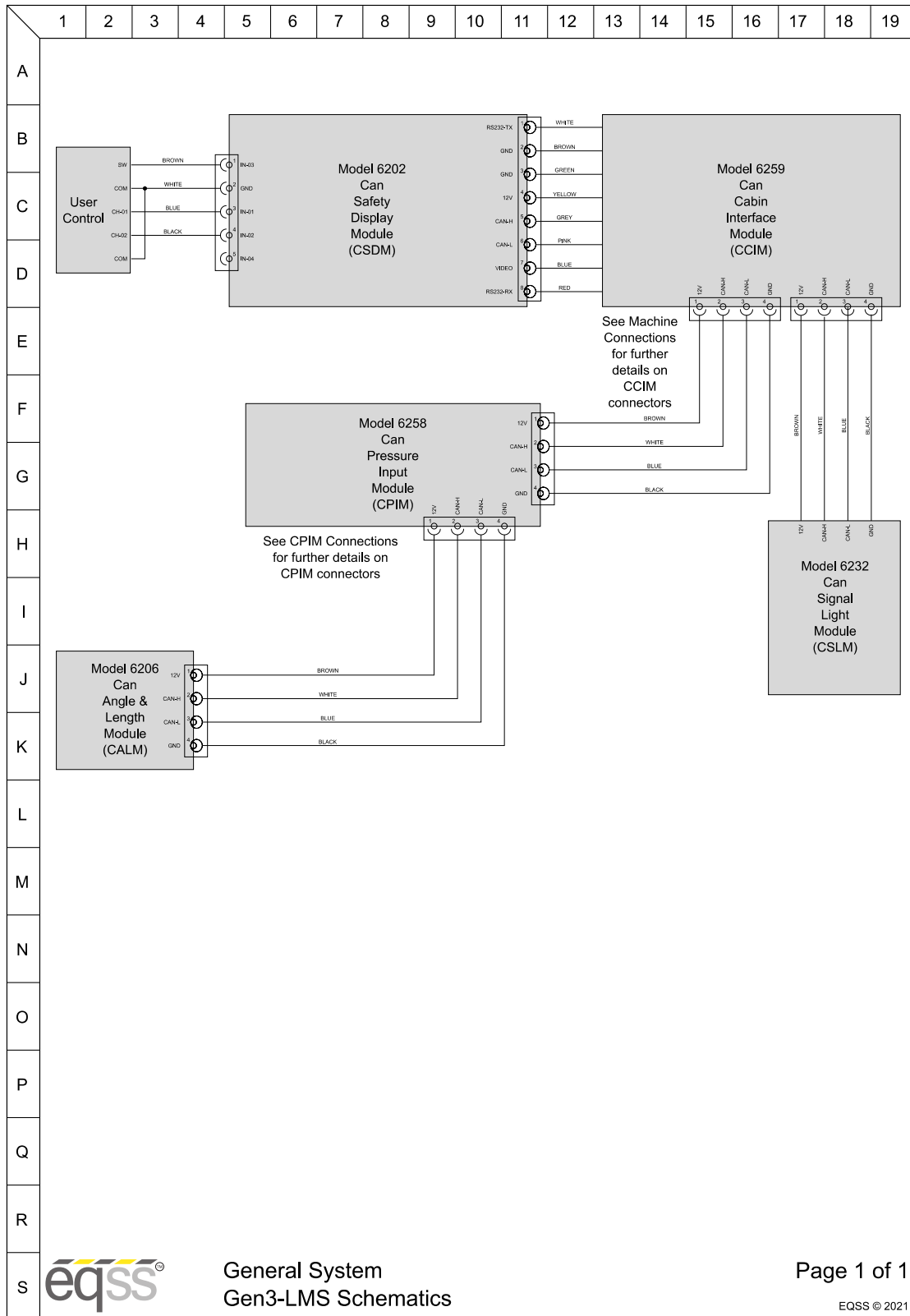

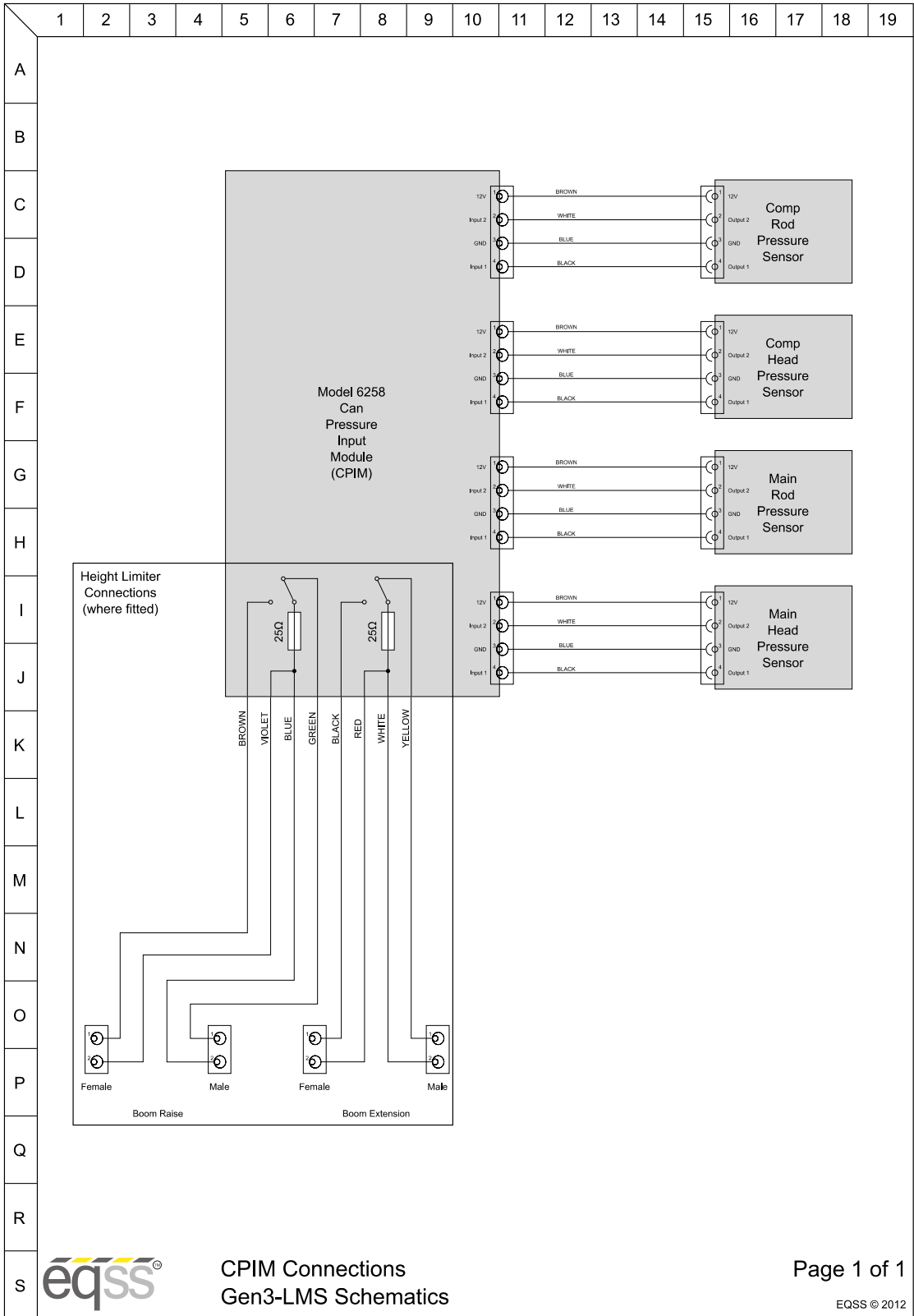

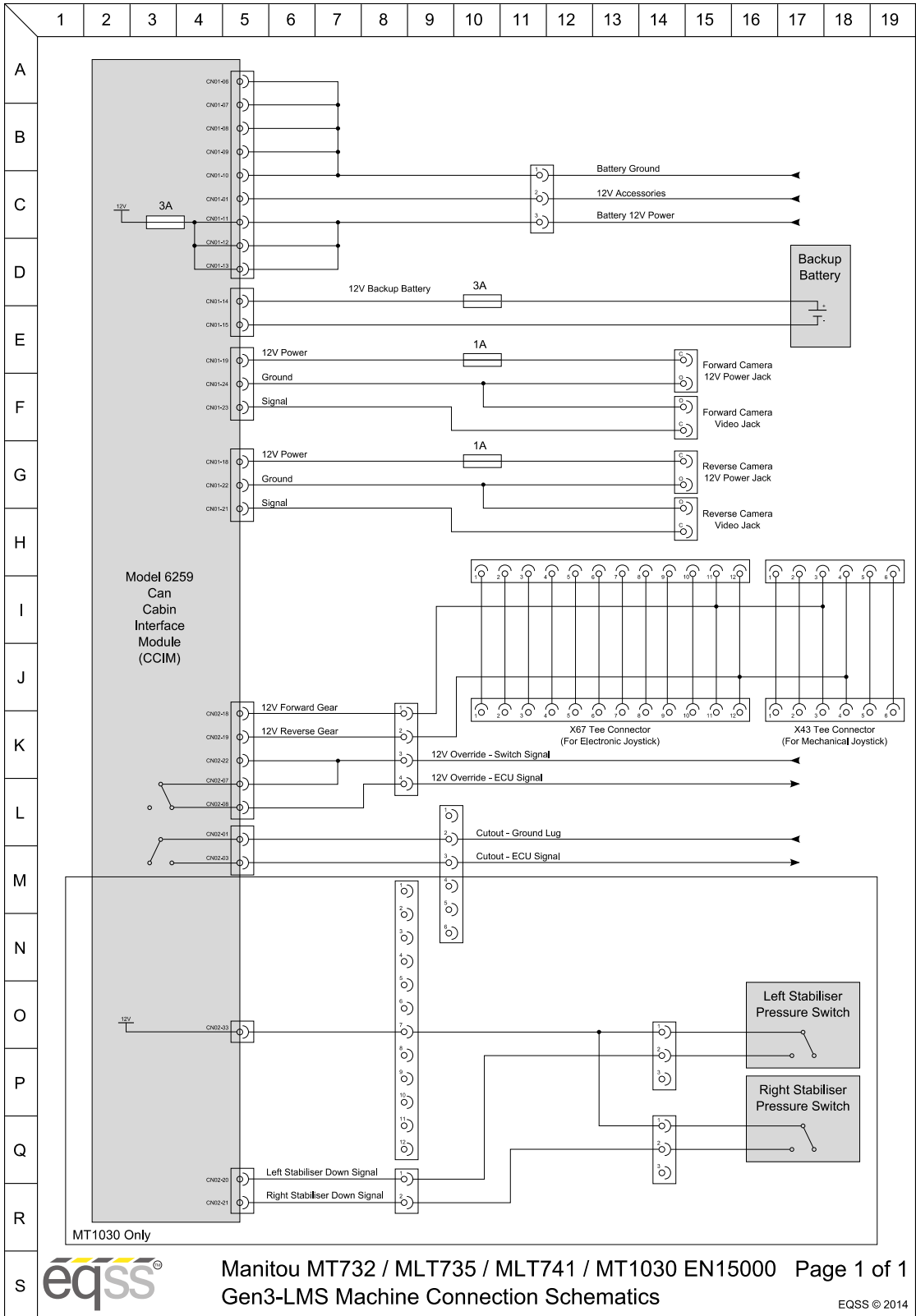

Appendix A: Attaching Display Connectors

The procedure below describes the correct method of attaching the cables to the screw lock connectors on the display.



If the M12 screw lock connectors on the display are over tightened, it will twist the connector pins attaching the connector to the PCB.

<i>Step</i>	<i>Description</i>	<i>Diagram</i>
1.	<p>Connect the cable from the user control to the top 5 pin connector on the display.</p> <p>Connect the cable from the CCIM to the bottom 8 pin connector on the display.</p>	
2.	<p>Line up the alignment hole on the cable connector with the alignment notch on the display connector.</p>	





<i>Step</i>	<i>Description</i>	<i>Diagram</i>
3.	Push the female connector from the cable into the male connector on the display.	
4.	Rotate the nut on the female connector by hand in a clockwise direction, until the tension on the nut starts to increase.	
5.	Push the cable in again and repeat steps 3 and 4 until the connector is secure.	

Table 21: Install Display Connector Procedure

 The method to correctly secure the cable is to push-twist-push-twist until the connector is fully inserted and secure. This will minimise the twisting force applied to the connector.

Below is a picture of a damaged connector on the PCB inside the display. This damaged occurred because the connector was over tightened.

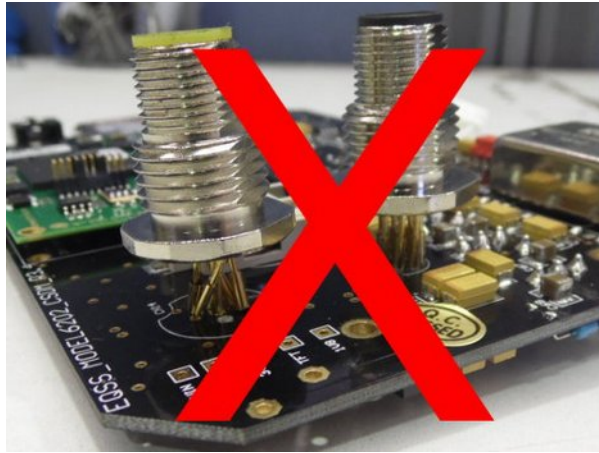

Illustration 5: Damaged Display Connector



Do not use any tools to tighten the connector.



Illustration 6: Do Not Use Tools To Tighten Connector



Do not over-tighten the nuts on the back of the display connectors. These nuts should only be hand tightened. If the nuts are overtightened it will damage the PCB inside the display.



Illustration 7: Do Not Over Tighten Nuts



Damage to the display connectors is not covered under warranty.

Appendix B: Reattach Ferrites

If the clip-on ferrites on the displays are removed during installation, they will need to be reattached as shown in the procedure below.

 If the ferrites are not reinstalled or attached in the specified location the Gen3-LMS kit will not meet the AS/NZS CISPR 22:2006 certification.

<i>Step</i>	<i>Description</i>	<i>Diagram</i>
1.	<p>Attach the two clip-on ferrites at a location of 60 mm and 260 mm from the start of the connector to the start of the ferrite.</p> <p>Do this for both the CCIM and user control cables that plug into the display.</p>	

Table 22: Reattach Ferrites Procedure

Indexes and Tables

Illustration Index

Illustration 1: Machine Boom.....	9
Illustration 2: Machine Chassis.....	10
Illustration 3: Cable Reeler Mounting Position.....	15
Illustration 4: Light Tower Bracket Mounting Position.....	28
Illustration 5: Damaged Display Connector.....	50
Illustration 6: Do Not Use Tools To Tighten Connector.....	50
Illustration 7: Do Not Over Tighten Nuts.....	51

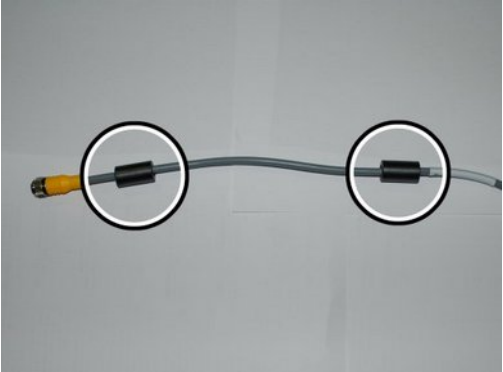
Index of Tables

Table 1: Component Installation Index.....	7
Table 2: Cable Installation Index.....	8
Table 3: Cover removal.....	12
Table 4: Cable Reeler Installation.....	14
Table 5: Pressure Manifold Installation.....	17
Table 6: Compensation Pressure Sensor Installation.....	18
Table 7: Reverse Camera Installation.....	20
Table 8: SPU Cable Harness Installation.....	21
Table 9: Forward Camera Installation.....	23
Table 10: Stabiliser Cable Harness Installation.....	26
Table 11: Light Tower Installation.....	27
Table 12: Joystick Cable Harness Installation.....	29
Table 13: Can Pressure Input Module (CPIM) Installation.....	30
Table 14: External Cable Completion.....	32
Table 15: Display Installation.....	33
Table 16: User Input Control Installation.....	34
Table 17: CCIM Installation.....	35
Table 18: Cabin Loom Installation.....	38
Table 19: Finalisation.....	41
Table 20: Sensor Calibration.....	44
Table 21: Install Display Connector Procedure.....	49
Table 22: Reattach Ferrites Procedure.....	52

Equipment Safety Systems Pty. Ltd. ABN: 31 061 789 151
75 Naxos Way, Keysborough 3173, Victoria, Australia

Tel: +61 3 8770 6555
Fax: +61 3 8770 6590
Web: www.eqss.com.au